



NOW AVAILABLE IN HORIZONTAL & VERTICAL FORMAT



BOXER

PACKAGED SOLUTIONS

AIR HANDLING MADE SIMPLE



FOR THE COMPLETE VENTILATION SOLUTION



AT THE FOREFRONT OF PACKAGED SOLUTIONS FOR OVER 20 YEARS

Nuaire has been at the forefront of packaged AHUs for over 20 years, designing and manufacturing market leading ranges.

When launched in 2000, Ecosmart Boxer revolutionised the industry by providing the best solution for performance and energy efficiency, then enhanced it with the Ecosmart 'plug and play' control.

Fast forward sixteen years and the **New Boxer Packaged Solution (BPS)** has been designed, engineered and tested to provide **the most efficient, best performing, most compact and easiest to select AHU on the market.**

BPS can be supplied in many configurations to suit the project or application and is **available with either a high efficiency plate HX (ErP 2018) or thermal wheel (ErP 2018).** BPS also has options for recirculation, heating and cooling upon request.

BPS offers full control flexibility and is complimented with the new Ecosmart Control Platform of Ecosmart Classic, Connect or Adapt (with Trend).

All packaged controls are inbuilt and factory tested by Nuaire.



▲ Model shown: Vertical Plate Heat Exchanger Unit shown split into 3 sections.

▲ Model shown: Horizontal Plate Heat Exchanger Unit shown split into 3 sections.



DUTY FOR HORIZONTAL & VERTICAL UNITS

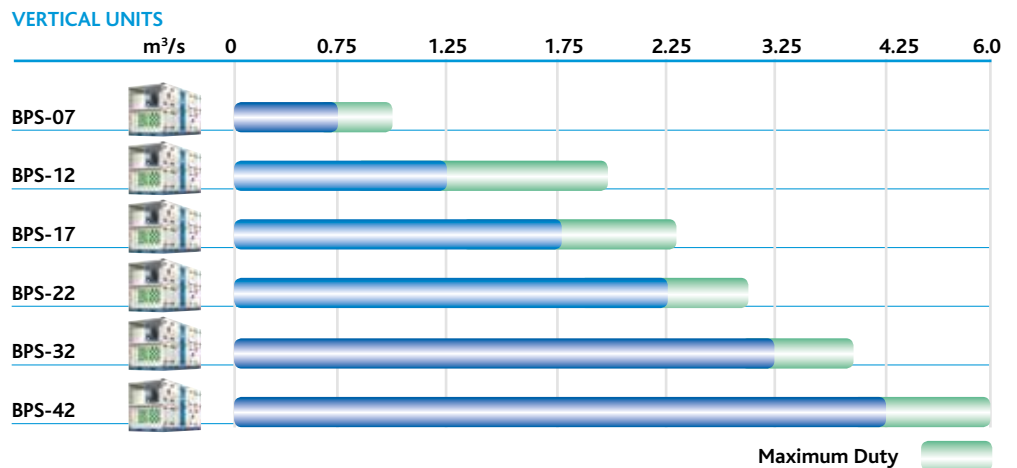
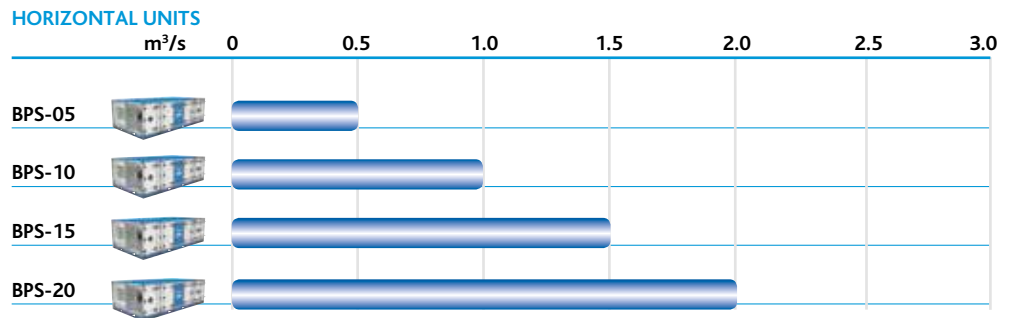

▲ Model shown: Vertical Thermal Wheel Unit.

▲ Models shown: Horizontal & Vertical Plate Heat Exchanger Units.

BOXER PACKAGED SOLUTIONS CONTENTS

CLASSIFICATION & REGULATIONS	4	BPS HORIZONTAL UNITS HANDINGS & AIRFLOW	28	BPS VERTICAL UNITS ANCILLARIES	64
BPS Classification	4	BPS HORIZONTAL UNITS ANCILLARIES	30	BPS WITH MITSUBISHI CONDENSING UNIT	72
Building Regulations Part L2A & Section 6	5	BPS VERTICAL UNITS TECHNICAL DATA	38	BPS CONSULTANT SPECIFICATION	74
BPS FEATURES & BENEFITS	6	BPS Unit 07	38	BPS Units Specification	74
BPS External Features & Benefits	6	BPS Unit 12	42	Ecosmart Control Platform Specification	75
BPS Internal Features & Benefits	8	BPS Unit 17	46	ECOSMART CONTROL	76
BPS HORIZONTAL UNITS TECHNICAL DATA	12	BPS Unit 22	50	Ecosmart Control Platform Overview	76
BPS Unit 05	12	BPS Unit 32	54	Features of Controls	78
BPS Unit 10	16	BPS Unit 42	58	Sensors and Enablers	80
BPS Unit 15	20	BPS VERTICAL UNITS HANDINGS & AIRFLOW	62		
BPS Unit 20	24				

BPS BOXER PACKAGED SOLUTIONS - CLASSIFICATION FEATURES

BS EN 1886:2007 "Ventilation for buildings — Air handling units — Mechanical performance" sets out the measurement and classification standard for AHUs.

The key criteria are:

- Air leakage [L]
- Thermal bridging [TB]
- Mechanical strength or deflection [D]
- Thermal transmittance [T]

All of these are measured and rated against tabulated values to give a grade, 1 being the highest in each classification.



L1 CASING AIR LEAKAGE CLASS [L]

Our construction has passed positive and negative pressure tests, confirming L1 classification. L1 means that the unit shall not leak more than 0.22 l/s per m² of outer face area of positive pressure section and 0.15 l/s per m² of outer face area of negative pressure section, under test conditions. **BPS has a classification of L1.**

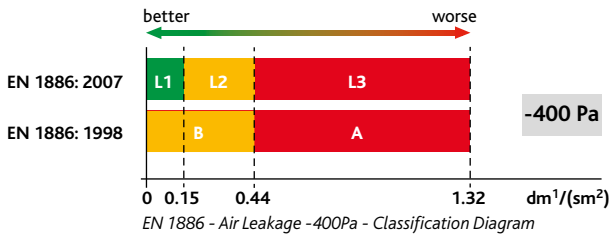

CASING AIR LEAKAGE @ -400 Pa

Class	Max leakage rate (f ₇₀₀) (lx s ⁻¹ x m ⁻²)	Filter Class (EN 779)
L3	1.32	G1 to F7
L2	0.44	F8 to F9
L1	0.15	Superior to F9

EN 1886 - Casing Air Leakage Classifications at Negative Pressure

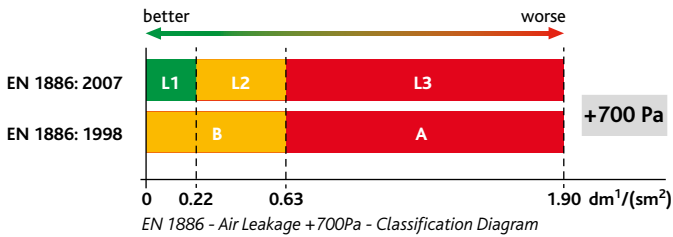

CASING AIR LEAKAGE @ +700 Pa

Class	Max leakage rate (f ₄₀₀) (lx s ⁻¹ x m ⁻²)	Filter Class (EN 779)
L3	1.9	G1 to F7
L2	0.63	F8 to F9
L1	0.22	Superior to F9

EN 1886 - Casing Air Leakage Classifications at Positive Pressure



TB1 THERMAL BRIDGING OF CASING CLASS [TB]

A high thermal bridging factor is achieved by separation of the conductive metallic internal and external surfaces, with an insulating material. This will provide a unit with the lowest 'condensation potential' and minimise the damage/hazards this may cause. **BPS has a classification of TB1.**

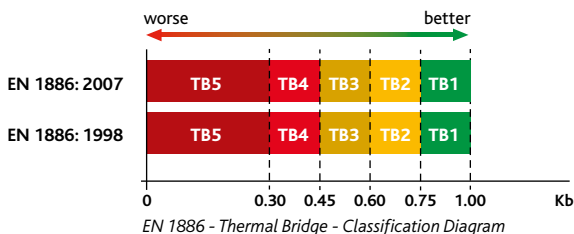

THERMAL BRIDGING FACTOR

Class	Thermal Bridging Factor (kb)
TB1	0.75 < K _b < 1
TB2	0.6 < K _b ≤ 0.75
TB3	0.45 < K _b ≤ 0.6
TB4	0.3 < K _b ≤ 0.45
TB5	No requirements

EN 1886 - Thermal Bridge - Classifications



D1 MECHANICAL STRENGTH OF CASING DEFLECTION [D]

The case strength of an AHU is important for product safety and longevity. If the case were unable to withstand the stresses applied to it in normal operation, air would eventually leak out, water may leak the unit aesthetic would suffer and damage may lead to malfunction or injury. D1 means the case shall not deflect more than 4mm per meter under test conditions. **BPS has a classification of D1.**



CASING STRENGTH

Class	Maximum relative deflection (mm x m ⁻¹)
D3	Exceeding 10
D2	10
D1	4

EN 1886 - Casing Strength - Classification Table



T2 THERMAL TRANSMITTANCE [T]

Minimising heat loss (or unwanted gain) requires insulation within panels and ductwork etc. Insulation choice is a balance of thermal transmittance, sound absorption, weight, cost and ease of manufacture. Thermal transmittance is rated as a 'U value' of W/m²/K and we have achieved T2 where this U value is below 1. **BPS has a classification of T2.**

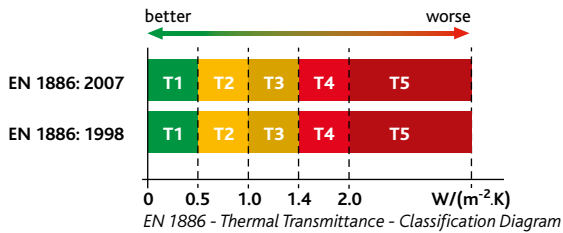

THERMAL TRANSMITTANCE

Class	Thermal Transmittance (U) (W x m ⁻² x K ⁻¹)
T1	U < 0.5
T2	0.5 < U ≤ 1
T3	1 < U ≤ 1.4
T4	1.4 < U ≤ 2
T5	No requirements

EN 1886 - Thermal Transmittance - Classifications

BPS BOXER PACKAGED SOLUTIONS - COMPLYING WITH BUILDING REGULATIONS

The following information is relevant to the selection of fans for Ventilation Systems, indicating the maximum specific fan powers allowed under Part L (Refer to the Non-domestic Building Services Compliance Guide: 2013 Edition for further details).



The SFP for the entire system (including both supply & extract fans) shall be less than that allowed by these figures. The following tables are the maximum values allowed under Building Regulations when finally commissioned.

Air distribution system	Specific fan power (W/(l/s))	
	New Buildings	Existing Buildings
Central balanced mechanical ventilation system with heating and cooling	1.6	2.2
Central balanced mechanical ventilation system with heating only	1.5	1.8
All other central balanced mechanical ventilation systems	1.1	1.6
Zonal supply system where the fan is remote from the zone, such as ceiling void or roof mounted units	1.1	1.4
Zonal extract system where fan is remote from zone	0.5	0.5
Zonal supply and extract ventilation system such as ceiling void or roof units serving a single room or zone with heating and heat recovery	1.9	1.9
Local balanced supply and extract ventilation system such as wall / roof units serving a single area with heat recovery	1.6	1.6
Local supply or extract ventilation units such as window / wall / roof units serving a single area (e.g. toilet extract)	0.3	0.4
Other local ventilation supply or extract units	0.5	0.5
Fan assisted terminal (VAV) unit	1.1	1.1
Fan coil units (rating weighted average*)	0.5	0.5
Kitchen extract, fan remote from zone with grease filter	1.0	1.0

*Note: The weighted average is calculated by the following formula:

$$\frac{P_{\text{mains},1} \cdot \text{SFP}_1 + P_{\text{mains},2} \cdot \text{SFP}_2 + P_{\text{mains},3} \cdot \text{SFP}_3 + \dots}{P_{\text{mains},1} + P_{\text{mains},2} + P_{\text{mains},3} + \dots}$$

where P_{mains} is useful power supplied from the mains in W

Extending SFP for additional components in new and existing buildings

Component	(SFP (W/(l/s)))
Additional return filter for heat recovery	+0.1
HEPA filter	+1.0
Heat recovery - thermal wheel system	+0.3
Heat recovery - other systems	+0.3
Humidifier / dehumidifier (air conditioning system)	+0.1

Example: For a central mechanical ventilation system with heating and cooling, and heat recovery via a plate heat exchanger plus return filter:

$$\text{SFP} = 1.6 + 0.3 + 0.1 \text{ W/(l/s)} \\ = 2.0 \text{ W/(l/s)}$$

Recommended minimum dry heat recovery efficiency for heat exchangers in new and existing buildings

Heat exchanger type	Dry Heat recovery efficiency
Plate heat exchanger	50%
Heat pipes	60%
Thermal wheel	65%
Run around coil	45%

SECTION 6 (2015 EDITION)

Permissible maximum specific fan power and pressure drop in air distribution systems.



Maximum specific fan powers in air distribution systems new and existing buildings.

System type	Specific fan power (W/(l/s))	
	New Buildings	Existing Buildings
Central balanced mechanical ventilation system with heating and cooling	1.6	2.2
Central balanced mechanical ventilation system with heating only	1.5	1.8
All other central balanced mechanical ventilation systems	1.1	1.6
Zonal supply system where fan is remote from the zone, such as ceiling void or roof mounted units	1.1	1.4
Zonal extract system where fan is remote from zone	0.5	0.5
Zonal supply and extract ventilation units, such as ceiling void or roof units serving single room or zone with heating and heat recovery	1.9	1.9
Local balanced supply and extract ventilation system such as wall/ roof units serving single area with heat recovery	1.6	1.6
Local supply or extract ventilation units such as window/ wall/ roof units serving single area (e.g. toilet extract)	0.3	0.4
Other local ventilation supply or extract units	0.5	0.5
Fan assisted terminal VAV unit	1.1	1.1
Fan coil unit (rating weighted average*)	0.5	0.5
Kitchen extract, fan remote from zone with grease filter	1.0	1.0

*The weighted average is calculated by the following formula:

$$\frac{P_{\text{mains},1} \times \text{SFP}_1 + P_{\text{mains},2} \times \text{SFP}_2 + P_{\text{mains},3} \times \text{SFP}_3 + \dots}{P_{\text{mains},1} + P_{\text{mains},2} + P_{\text{mains},3} + \dots}$$

where P_{mains} is useful power supplied from the mains in W

Extending SFP for additional components in new and existing buildings

Component	SFP (W/(l/s))
Additional return filter for heat recovery	+0.1
HEPA filter	+1.0
Heat recovery – thermal wheel system	+0.3
Heat recovery – other systems	+0.3
Humidifier/ dehumidifier (air conditioning system)	+0.1

Recommended minimum dry heat recovery efficiency for heat exchangers in new and existing buildings

Heat exchanger type	Dry heat recovery efficiency
Plate heat exchanger	50%
Heat pipes	60%
Thermal wheel	65%
Run around coil	45%

BPS BOXER PACKAGED SOLUTIONS - EXTERNAL FEATURES AND BENEFITS

BOXER PACKAGED SOLUTIONS

■ ONE PIECE PACKAGED SOLUTION

The **BPS** unit is a pre-selected catalogue range which is manufactured in sections for ease of manoeuvring on site. Unit modules may be clamped together on site using the pre-fitted 3D Intelli-clamp links.

■ WEATHERPROOFED AS STANDARD

BPS unit & ancillary modules are weatherproof as standard. All sections and modules have a flat roof which has a hydrophobic coating aiding water run off.

■ UNIQUE CONSTRUCTION

BPS has a unique construction which is a 'Patented applied' for design incorporating a thermally broken extrusion with fixed panels sandwiched together removing the requirement for any additional silicon sealant to be added on site.

This super strong construction meets class D1 (Deflection) see page 4 for details.

■ LOW NOISE SOURCE

50mm Double skinned panels ensure low noise levels. Optional, additional attenuators are available to provide a continuous acoustic solution.

■ ALUZINC FINISH

BPS is manufactured from corrosion resistant Aluzinc. Aluzinc can last 5 times longer than galvanised steel.

■ INTEGRAL BASE FRAME

The structural base frame is raised for additional support and includes slots for fork lift arms for easy manoeuvring on site.

The base frame is powder coated in Nuaire blue.

■ PORT HOLES/LIGHTS AND CABLE GLANDS

BPS unit is supplied with port holes and internal lights on all fan sections. Each unit has 5 cable glands as standard.

■ HINGED OR REMOVABLE ACCESS PANELS

All hinged access panels will be lockable and removable via locked hinges which can be opened for panel removal. All keys are identical and will open any handle or hinge.

The hinges do not need to be unlocked in normal operation of opening and closing.

■ OPTIONAL CONDENSER UNIT/ MATCHING FRAME

The **BPS** unit is available with a range of heating and cooling coils including a reverse cycle DX coil with matching condenser. The standard condenser is Mitsubishi Mr Slim which is supplied loose for integration on site (by others).

If a condenser is ordered* two pre-wired PAC controllers are installed on the internal control panel of the **BPS** unit (only available with Ecosmart Connect or Adapt control).

Condensing units are supplied with base frames. Painted Condensers are available for coastal environments.

*Refer to page 72 for further details.

■ ISOLATOR AS STANDARD

An IP66/67 lockable isolator is fitted on all models.

■ OPTIONAL EXTERNAL ANCILLARIES

Wide range of optional ancillaries including modular support frame, weather terminals, dampers, silencers, recirculation modules, heating & cooling options.

■ 5 YEAR WARRANTY

BPS with Ecosmart Classic, Connect or Adapt controls have a 5 year warranty.

Mitsubishi Condensing units when supplied with **BPS** and PAC control have a 3 year warranty, see page 72 for details. Contact Nuaire for further details.

■ **BPS** UNITS ARE AVAILABLE WITH
MITSUBISHI MR SLIM CONDENSERS
(SEE PAGE 72 FOR DETAILS)



▲ Model shown: Vertical Plate Heat Exchanger Unit.



■ ONE PIECE PACKAGED SOLUTION. VERTICAL & HORIZONTAL UNITS EASILY SPLIT INTO THREE OR FOUR SECTIONS



■ UNIQUE CONSTRUCTION DESIGN, (PATENT APPLIED) NO REQUIREMENT FOR ADDED SILICONE



■ CODING **B 8 15 H / LR / CO - L**
 | | | | | | | |
 1 2 3 4 5 6 7 8

1. BOXER Package Solution Range	
2. ERP year:	8 = 2018
3. Horizontal Unit size:	05, 10, 15, 20
Vertical Unit size:	07, 12, 17, 22, 32 or 42
4. Heat Exchanger:	V = Plate HX (Vertical units) T = Thermal Wheel (Vertical units) H = Plate HX (Horizontal units)
5. Heater:	L = LPHW, E = Electric, N = No Electric or LPHW
6. Cooling:	R = Reverse Cycle*** X = DX** C = Chilled Water N = No Cooling
7. Control type:	AT = Ecosmart Adapt (Trend) CO = Ecosmart Connect ES = Ecosmart Classic BC = Basic Control
8. Handing:	L = Left, R = Right

* Condenser Unit and control by others.
 **Ecosmart Connect & Adapt models only.



◀ Model shown: Horizontal Plate Heat Exchanger Unit.

■ OPTIONAL MODULAR SUPPORT FRAMES

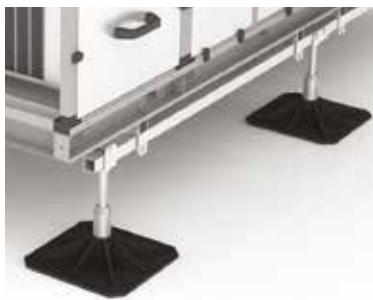

■ HINGED OR REMOVABLE ACCESS PANELS

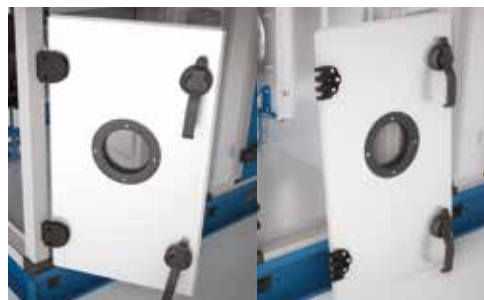

■ INTEGRAL BASE FRAME WITH SLOTS FOR FORK LIFT



BPS BOXER PACKAGED SOLUTIONS - INTERNAL FEATURES AND BENEFITS

■ HIGHLY ENERGY EFFICIENT

HEAT EXCHANGER

BPS is available with either a plate or thermal wheel heat exchanger.

Thermal Wheels are ErP 2018 compliant.

As standard there is a purge sector and bypass provided by interrupting the wheel rotation.

The plate HX is 2018 ErP compliant. (See technical information). The heat exchanger has coefficients of up to 85%+.

■ ENERGY SAVING EC MOTOR TECHNOLOGY

BPS has performance optimised backward curved impellers and IP54 EC motors which provide low specific fan powers.

■ EASILY REMOVABLE BLOWERS FOR QUICK & EASY MAINTENANCE

Blowers are mounted on self-supporting frame.

For ease of maintenance the frame can be removed through a lifted off access panel.

■ RE-CIRCULATING OPTION

Recirculation is provided within an ancillary module which houses a mixing damper.

The operation will be open/close.

The system will allow recirculation only when called for in the standard control strategy of Ecosmart Connect or Adapt.

■ ELECTRIC HEATER

The electric heater module is separate from the main packaged unit. Finned air-heater elements provide the most efficient method with lower surface temperature operation which also prevent 'burnt dust' odours.

■ INTERCHANGEABLE COILS

BPS has a wide range of coil options. All coils are mounted on a common drain tray and slide assembly allowing them to be interchangeable without any modification to the unit. Two coils can be fitted into the unit at one time.

■ LPHW HEATER

The LPHW* coil is housed within the unit and is interchangeable with other 'wet' coil options.

*LPHW frost protection ancillary is also available.

■ CHILLED WATER COOLING

The chilled* water coil is housed within the unit and is interchangeable with other 'wet' coil options. *LPHW & Chilled water coils will not have valve & actuator assemblies fitted as standard. These are optional ancillaries, contact Nuaire. (2 and 3 port valve options available).

■ DIRECT EXPANSION (DX)

All DX coils used in BPS are suitable for reverse cycle, capable of providing heating and cooling. Our DX reverse cycle packages within Ecosmart Connect and Adapt options come with a matched Mitsubishi Condenser, supplied loose for integration by others.

A coil-only option is available upon request, where a 0-10V demand signal may be utilised by others to control the external refrigerant system (not supplied).

■ CONDENSATE TRAY WITH BUILT IN PUMP

A condensate pump is fitted as standard (on Plate HX units and Thermal Wheel HX units with Cooling) and incorporates an alarm* function.

The pump has a capacity of 50l/hr with 20m (six storeys) of head pressure available. All drains within the unit (for coils and heat exchanger) will be fitted with a vacuum-formed plastic corner allowing lowest point and gravity flow for drain away. *If the alarm is triggered the unit will automatically be placed in bypass mode minimising further condensate production. Unit operation will otherwise be unaffected.

■ FROST PROTECTION

The plug and play frost protection modules (Electric & LPHW) are stand alone, designed to protect the unit internals from low-temperature damage.

■ BYPASS AS STANDARD

In order to avoid unnecessary heating of the outdoor air in the summer, the bypass damper can be opened. With this damper setting a night cooling can be performed using the control system (Ecosmart Connect & Adapt models only).

The cool outdoor air is then blown directly into the room past the heat exchanger at night.

■ INTERCHANGEABLE FILTERS

Standard filter arrangement will include M5 filters in the extract section and a combination of G4 pre-filter and F7 bag filter within the supply air stream. For other filter options contact Nuaire.

■ CONSTANT PRESSURE CONTROL AS STANDARD

Improve energy performance of a building using a centralised ventilation system, and guarantees lower energy costs for the end user (Applies to Connect and Adapt models only).

■ NEW BUILT IN ECOSMART CLASSIC, CONNECT OR ADAPT (TREND) CONTROL OPTIONS

Energy efficient demand control ventilation solution utilising the very latest efficient Ecosmart control platform options:

Ecosmart Classic control was the first plug and play control on the market and has been a Nuaire core product for the last 13 years. Classic provides 0-10V BMS interface, trickle and boost as standard.

Ecosmart Connect demand based control option delivers network connectivity and advanced functionality. Full BMS integration via Bacnet MS/TP (by others). Connect can be expanded to Bacnet IP with a separate optional router.

Ecosmart Adapt is designed to meet site/project requirements – Ecosmart Adapt with Trend IQ4E with 8DO expansion module and full Bacnet IP integration (by others). Trend is the current standard option however, other control types such as Cylon, Siemens or Schneider can be incorporated, contact Nuaire for details.

Ecosmart Classic, Connect & Adapt are available with a wide range of sensors & enablers.

All control panels are internally fitted and have a 5 year warranty.

Note: Basic control model also available, contact Nuaire for details.



■ INTERCHANGEABLE FILTERS WHICH EASILY SLIDE IN AND OUT



■ EASILY REMOVABLE BLOWERS FOR QUICK & EASY MAINTENANCE



■ HIGHLY ENERGY EFFICIENT PLATE HEAT EXCHANGER (THERMAL WHEEL - VERTICAL UNITS ONLY)



▲ Model shown: Horizontal Plate Heat Exchanger Unit.

▼ Model shown: Vertical Thermal Wheel Unit.



■ OPTIONAL BUILT-IN ECOSMART CLASSIC, CONNECT OR ADAPT CONTROL (Connect Control shown with PAC controller).



BPS BOXER PACKAGED SOLUTIONS - HORIZONTAL UNITS

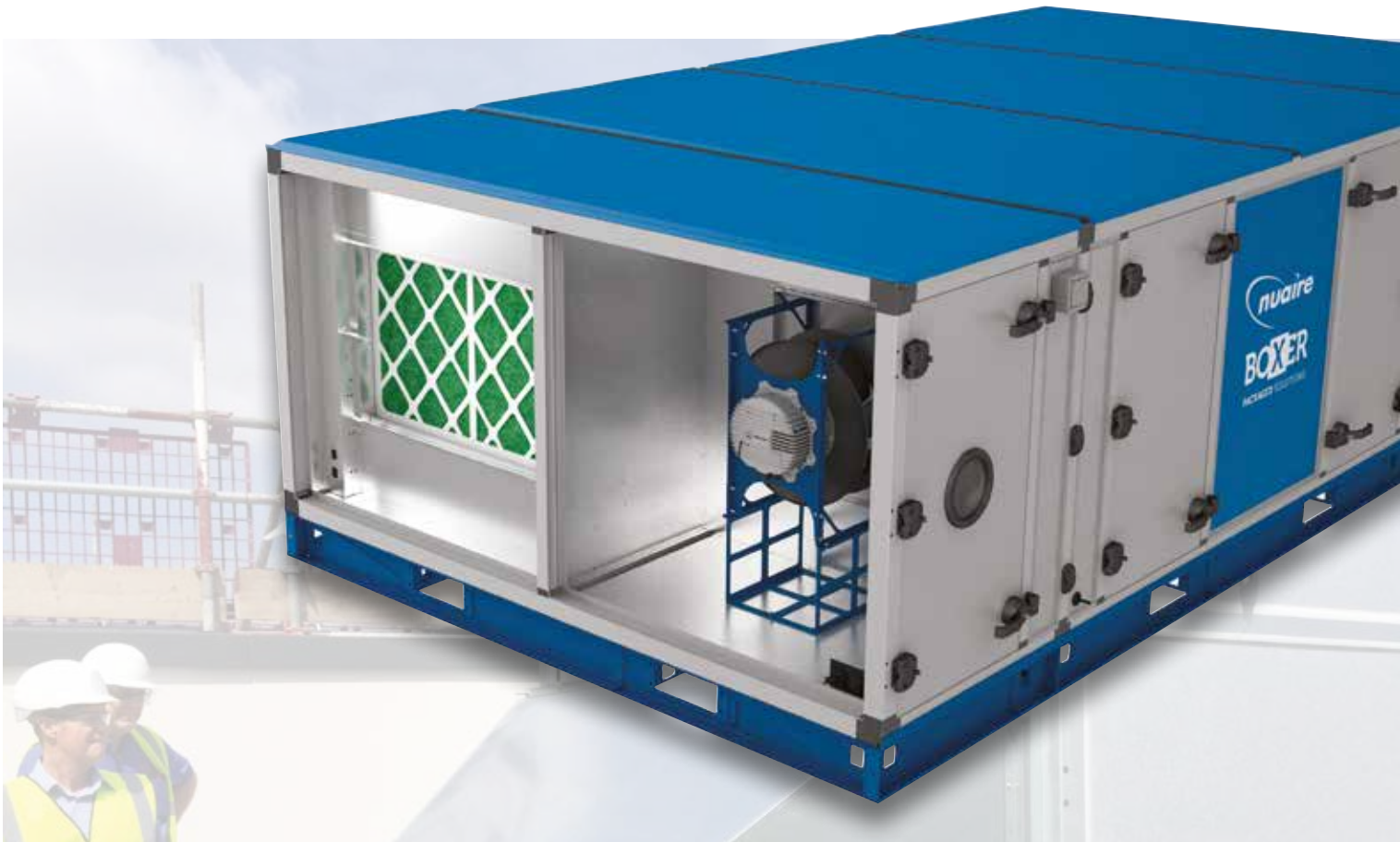

DUTY FOR HORIZONTAL UNITS

HORIZONTAL
UNITS

BPS-05



BPS-10



BPS-15



BPS-20



HORIZONTAL PLATE HEAT EXCHANGER UNITS SECTION CONTENTS

BPS HORIZONTAL UNITS TECHNICAL DATA	12
BPS Unit 05	12
BPS Unit 10	16
BPS Unit 15	20
BPS Unit 20	24
BPS HORIZONTAL UNITS HANDINGS & AIRFLOW	28
BPS HORIZONTAL UNITS ANCILLARIES	30
BPS HORIZONTAL UNITS WITH MITSUBISHI CONDENSING UNIT	72
BPS CONSULTANT SPECIFICATION	74
BPS HORIZONTAL UNITS WITH ECOSMART CONTROL	76



BPS BOXER PACKAGED SOLUTIONS - HORIZONTAL UNIT 05 - PERFORMANCE & TECHNICAL INFORMATION

BPS B805H PERFORMANCE FOR PLATE HEAT EXCHANGER UNIT

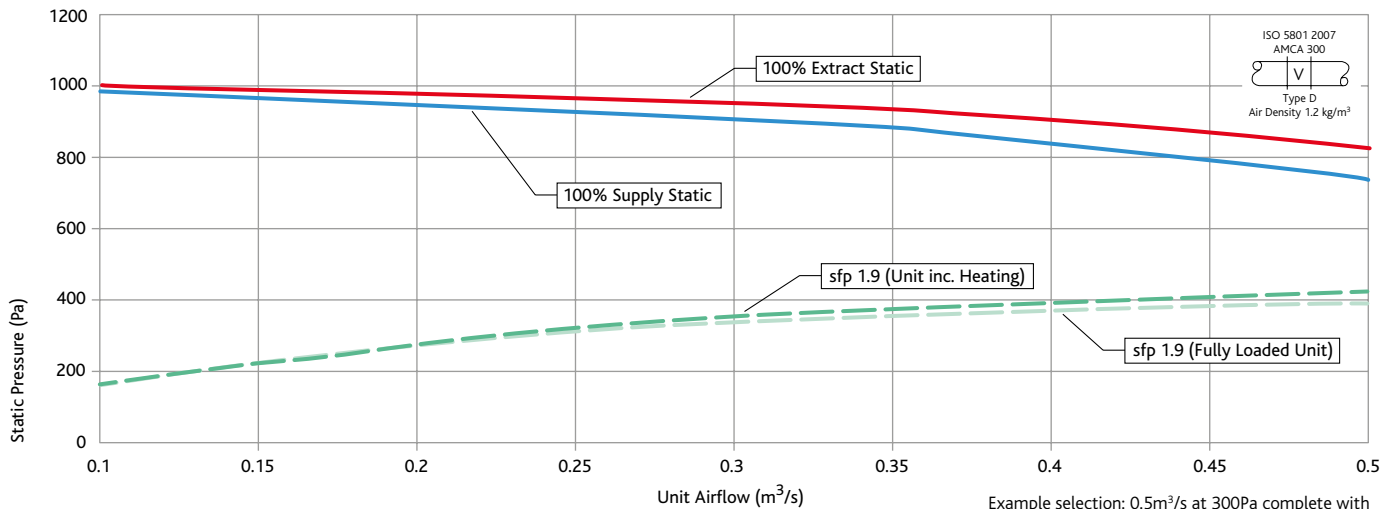

BPS B805H TECHNICAL INFORMATION

Unit Code	Voltage / Phase / Frequency	FLC (A)	Max Operating Temperature	Fan Speed (rpm)	Unit Weight (kg)	PACKAGED WEIGHT (kg)			
						Intake Exhaust Module	PHX Module	Supply Exhaust Module	Electric Heater Module
B805H/LR/**-#	400 / 3 / 50	8.7	40°C	3100	927	199	447	355	-
B805H/LR/**-#	400 / 3 / 50	4.2	40°C	3100	927	199	447	355	-
B805H/LN/**-#	400 / 3 / 50	4.2	40°C	3100	880	199	447	308	-
B805H/ER/**-#	400 / 3 / 50	8.7+18*	40°C	3100	1083	199	447	326	203
B805H/EC/**-#	400 / 3 / 50	4.2+18*	40°C	3100	1083	199	447	326	203
B805H/EN/**-#	400 / 3 / 50	4.2+18*	40°C	3100	1036	199	447	279	203
B805H/NR/**-#	400 / 3 / 50	8.7	40°C	3100	898	199	447	326	-
B805H/NC/**-#	400 / 3 / 50	4.2	40°C	3100	898	199	447	326	-
B805H/NN/**-#	400 / 3 / 50	4.2	40°C	3100	851	199	447	279	-

** Add relevant control option. i.e AT, CO, ES.

Add relevant handing. i.e L (Left) R (Right).

*FLC: Includes separate supply for a 12kW Heater element.

Please note: All weights displayed are estimated weights and are subject to change. Dimensions are case width and do not include for handles/terminals and switches.

Unit Code	PALLET CRATE DIMENSIONS (mm)			
	Intake / Exhaust Module	PHX Module	Supply / Exhaust Module	Electric / Heater Module
B805H/LR/**-#	950L x 1900W x 970H	1900L x 1900W x 970H	1350L x 1900W x 970H	-
B805H/LR/**-#	950L x 1900W x 970H	1900L x 1900W x 970H	1350L x 1900W x 970H	-
B805H/LN/**-#	950L x 1900W x 970H	1900L x 1900W x 970H	1350L x 1900W x 970H	-
B805H/ER/**-#	950L x 1900W x 970H	1900L x 1900W x 970H	1350L x 1900W x 970H	950L x 1900W x 970H
B805H/EC/**-#	950L x 1900W x 970H	1900L x 1900W x 970H	1350L x 1900W x 970H	950L x 1900W x 970H
B805H/EN/**-#	950L x 1900W x 970H	1900L x 1900W x 970H	1350L x 1900W x 970H	950L x 1900W x 970H
B805H/NR/**-#	950L x 1900W x 970H	1900L x 1900W x 970H	1350L x 1900W x 970H	-
B805H/NC/**-#	950L x 1900W x 970H	1900L x 1900W x 970H	1350L x 1900W x 970H	-
B805H/NN/**-#	950L x 1900W x 970H	1900L x 1900W x 970H	1350L x 1900W x 970H	-

** Add relevant control option. i.e AT, CO, ES.

Add relevant handing. i.e L (Left) R (Right).

*FLC: Includes separate supply for a 12kW Heater element.

Please note: All weights displayed are estimated weights and are subject to change. Dimensions are case width and do not include for handles/terminals and switches.

BPS BOXER PACKAGED SOLUTIONS - HORIZONTAL UNIT 05 - PERFORMANCE & TECHNICAL INFORMATION

BPS B805H (ErP 2018) NOISE DATA FOR PLATE HEAT EXCHANGER UNITS

Plate Heat Exchanger										
Fan Code	Type	63	125	250	500	1000	2000	4000	8000	(dBA@3m)
B805H	Open Discharge	74	59	68	60	54	45	37	25	44
B805H	Open Intake	69	62	71	69	64	61	58	54	
B805H	Open Supply	74	69	78	79	81	78	74	70	
B805H	Open Extract	69	62	71	69	64	61	58	54	
B805H	Breakout	74	69	78	79	81	78	74	70	

BPS B805H PLATE HEAT EXCHANGER UNIT - EFFICIENCY

B805H HEAT EXCHANGER EFFICIENCY

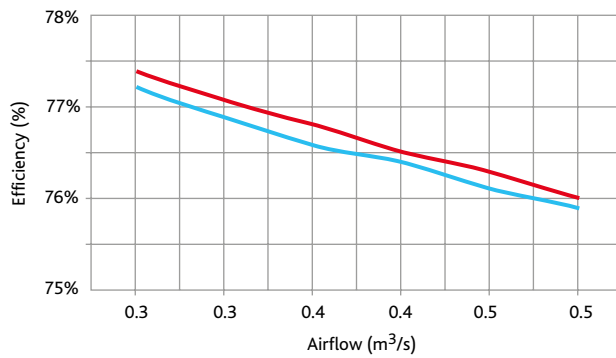

B805H HEAT EXCHANGER HEAT RECOVERY

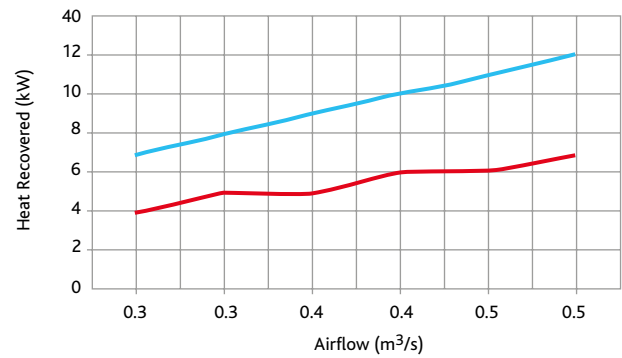

B805H HEAT EXCHANGER AIR-OFF TEMPERATURES

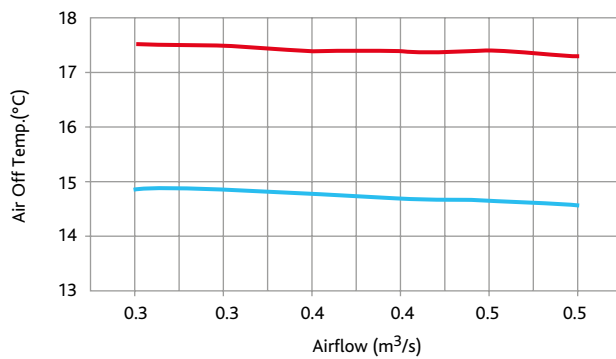

KEY:

- B805H @ 6°C Inlet
- B805H @ -5°C Inlet

All performance data based on indoor condition: 21°C @ 50% RH

BPS BOXER PACKAGED SOLUTIONS - HORIZONTAL UNIT 05 - COIL DATA

BPS B805H COIL DATA

UNIT CONFIGURATION		AIR INLET CONDITION		AIR CONDITION AFTER HX		WATER PARAMETERS		AIR CONDITION AFTER COIL	
Model Code	Airflow (m³/s)	Dry bulb (°C)	Relative Humidity (%)	Dry bulb (°C)	Relative Humidity (%)	Inlet temp. (°C)	Outlet temp. (°C)	Dry bulb (°C)	Relative Humidity (%)
B805H/*R	0.5	28.0	42.9	22.8	58.4	-	-	15.5	79.1
B805H/*R	0.5	10.0	70.0	18.7	39.9	-	-	30.0	20.1
B805H/*C	0.5	28.0	42.9	22.8	58.4	6.0	12.0	15.5	79.1
B805H/*C	0.5	28.0	42.9	22.8	58.4	8.0	14.0	15.5	79.1
B805H/*C	0.5	28.0	42.9	22.8	58.4	10.0	16.0	16.3	76.3
B805H/L*	0.5	10.0	70.0	18.1	39.9	82.0	71.0	30.0	20.1
B805H/L*	0.5	10.0	70.0	18.1	39.9	80.0	60.0	30.0	20.1
B805H/L*	0.5	10.0	70.0	18.1	39.9	60.0	40.0	30.0	20.1
B805H/*R	0.375	28.0	42.9	22.6	59.2	-	-	15.5	79.1
B805H/*R	0.375	10.0	70.0	18.8	39.6	-	-	30.0	20.1
B805H/*C	0.375	28.0	42.9	22.6	59.2	6.0	12.0	15.6	78.9
B805H/*C	0.375	28.0	42.9	22.6	59.2	8.0	14.0	15.6	78.9
B805H/*C	0.375	28.0	42.9	22.6	59.2	10.0	16.0	16.6	74.8
B805H/L*	0.375	10.0	70.0	18.8	39.6	82.0	71.0	30.0	20.1
B805H/L*	0.375	10.0	70.0	18.8	39.6	80.0	60.0	30.0	20.1
B805H/L*	0.375	10.0	70.0	18.8	39.6	60.0	40.0	30.0	20.1
B805H/*R	0.2	28.0	42.9	22.5	59.4	-	-	15.5	79.1
B805H/*R	0.25	10.0	70.0	18.9	39.3	-	-	30.0	20.1
B805H/*C	0.25	28.0	42.9	22.5	59.4	6.0	12.0	15.5	79.1
B805H/*C	0.25	28.0	42.9	22.5	59.4	8.0	14.0	15.9	78.0
B805H/*C	0.25	28.0	42.9	22.5	59.4	10.0	16.0	17.0	73.7
B805H/L*	0.25	10.0	70.0	18.9	39.3	82.0	71.0	30.0	20.1
B805H/L*	0.25	10.0	70.0	18.9	39.3	80.0	60.0	30.0	20.1
B805H/L*	0.25	10.0	70.0	18.9	39.3	60.0	40.0	30.0	20.1

Note: performance is based on an indoor (or space, room etc.) condition of 21°C @ 50%RH.

	HX PERFORMANCE		DX COOLING		DX HEATING	CW COOLING		LPHW HEATING	UNIT PERFORMANCE			
	Free cooling (kW)	Heat recovery (kW)	Sensible (kW)	Gross (kW)	Capacity (kW)	Sensible (kW)	Gross (kW)	Capacity (kW)	Cooling (kW)	Heating (kW)	Water flow (l/s)	Coil Δp (kPa)
	3.1	-	4.4	5.2	-	-	-	-	7.5	-	-	-
	-	5.2	-	-	6.8	-	-	-	-	12.0	-	-
	3.1	-	-	-	-	4.4	5.2	-	7.5	-	0.206	8.7
	3.1	-	-	-	-	4.4	5.1	-	7.5	-	0.201	8.2
	3.1	-	-	-	-	3.9	4.9	-	7.0	-	0.194	7.6
	-	4.9	-	-	-	-	-	7.2	-	12.1	0.161	7.8
	-	4.9	-	-	-	-	-	7.2	-	12.1	0.088	2.6
	-	4.9	-	-	-	-	-	7.2	-	12.1	0.088	2.7
	2.4	-	3.2	3.8	-	-	-	-	5.6	-	-	-
	-	4.0	-	-	5.0	-	-	-	-	9.0	-	-
	2.4	-	-	-	-	3.2	3.8	-	5.6	-	0.152	5
	2.4	-	-	-	-	3.2	3.7	-	5.6	-	0.148	4.7
	2.4	-	-	-	-	2.7	3.6	-	5.1	-	0.144	4.5
	-	4.0	-	-	-	-	-	5.4	-	9.3	0.359	3.46
	-	4.0	-	-	-	-	-	5.4	-	9.3	0.197	1.18
	-	4.0	-	-	-	-	-	5.4	-	9.3	0.197	1.18
	1.3	-	1.7	2.6	-	-	-	-	3.0	-	-	-
	-	2.7	-	-	3.3	-	-	-	-	6.0	-	-
	1.7	-	-	-	-	2.1	2.6	-	3.8	-	0.102	2.4
	1.7	-	-	-	-	2.0	2.5	-	3.6	-	0.099	2.3
	1.7	-	-	-	-	1.7	2.4	-	3.3	-	0.096	2.2
	-	2.7	-	-	-	-	-	3.5	-	6.2	0.078	2.1
	-	2.7	-	-	-	-	-	3.5	-	6.2	0.043	0.08
	-	2.7	-	-	-	-	-	3.5	-	6.2	0.043	0.07

BPS BOXER PACKAGED SOLUTIONS - HORIZONTAL UNIT 10 - PERFORMANCE & TECHNICAL INFORMATION

BPS 810H PERFORMANCE FOR PLATE HEAT EXCHANGER UNIT

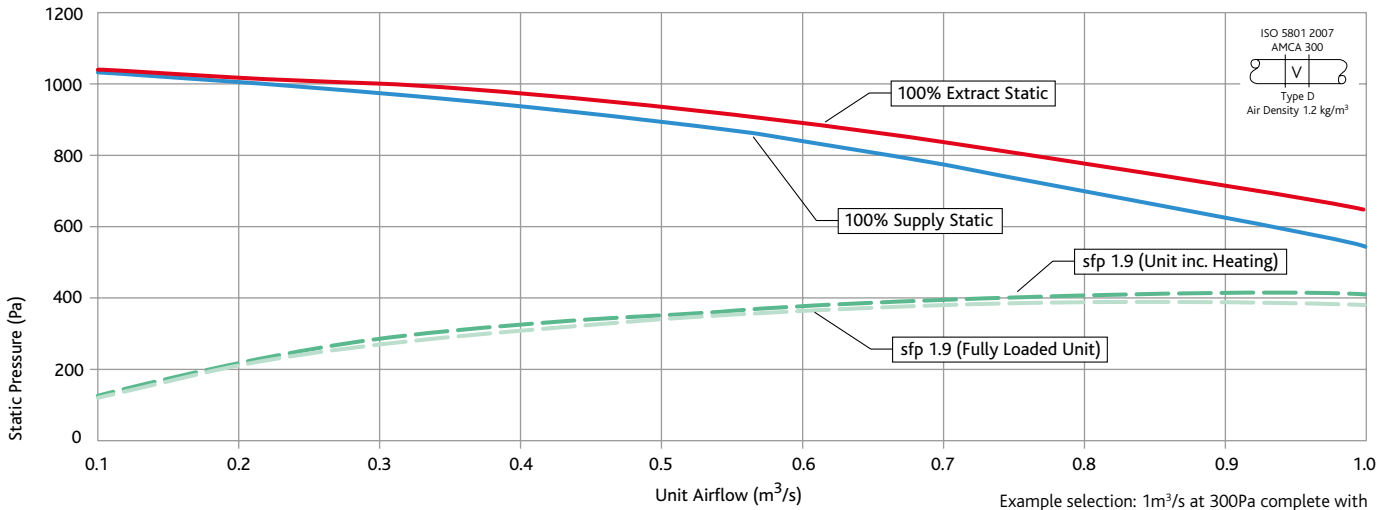

Example selection: 1m³/s at 300Pa complete with 2018 Plate Heat Exchanger, LPHW heater, Reverse cycle coil, Connect control, SFP = 1.8 W/(l/s)

BPS 810H TECHNICAL INFORMATION

Unit Code	Voltage / Phase / Frequency	FLC (A)	Max Operating Temperature	Fan Speed (rpm)	Unit Weight (kg)	PACKAGED WEIGHT (kg)			
						Intake Exhaust Module	PHX Module	Supply Exhaust Module	Electric Heater Module
B810H/LR/**-#	400 / 3 / 50	17.5	40°C	2450	1154	234	660	363	-
B810H/LC/**-#	400 / 3 / 50	13	40°C	2450	1154	234	660	363	-
B810H/LN/**-#	400 / 3 / 50	13	40°C	2450	1126	234	660	335	-
B810H/ER/**-#	400 / 3 / 50	17.5+27*	40°C	2450	1352	234	660	346	215
B810H/EC/**-#	400 / 3 / 50	13+27*	40°C	2450	1352	234	660	346	215
B810H/EN/**-#	400 / 3 / 50	13+27*	40°C	2450	1324	234	660	318	215
B810H/NR/**-#	400 / 3 / 50	17.5	40°C	2450	1137	234	660	346	-
B810H/NC/**-#	400 / 3 / 50	13	40°C	2450	1137	234	660	346	-
B810H/NN/**-#	400 / 3 / 50	13	40°C	2450	1109	234	660	318	-

** Add relevant control option. i.e AT, CO, ES.

Add relevant handing. i.e L (Left) R (Right).

*FLC: Includes separate supply for a 18kW Heater element.

Please note: All weights displayed are estimated weights and are subject to change. Dimensions are case width and do not include for handles/terminals and switches.

Unit Code	PALLET CRATE DIMENSIONS (mm)			
	Intake / Exhaust Module	PHX Module	Supply / Exhaust Module	Electric / Heater Module
B810H/LR/**-#	950L x 2150W x 1170H	2150L x 2150W x 1170H	1350L x 2150W x 1170H	-
B810H/LC/**-#	950L x 2150W x 1170H	2150L x 2150W x 1170H	1350L x 2150W x 1170H	-
B810H/LN/**-#	950L x 2150W x 1170H	2150L x 2150W x 1170H	1350L x 2150W x 1170H	-
B810H/ER/**-#	950L x 2150W x 1170H	2150L x 2150W x 1170H	1350L x 2150W x 1170H	950L x 2150W x 1170H
B810H/EC/**-#	950L x 2150W x 1170H	2150L x 2150W x 1170H	1350L x 2150W x 1170H	950L x 2150W x 1170H
B810H/EN/**-#	950L x 2150W x 1170H	2150L x 2150W x 1170H	1350L x 2150W x 1170H	950L x 2150W x 1170H
B810H/NR/**-#	950L x 2150W x 1170H	2150L x 2150W x 1170H	1350L x 2150W x 1170H	-
B810H/NC/**-#	950L x 2150W x 1170H	2150L x 2150W x 1170H	1350L x 2150W x 1170H	-
B810H/NN/**-#	950L x 2150W x 1170H	2150L x 2150W x 1170H	1350L x 2150W x 1170H	-

** Add relevant control option. i.e AT, CO, ES.

Add relevant handing. i.e L (Left) R (Right).

*FLC: Includes separate supply for a 18kW Heater element.

Please note: All weights displayed are estimated weights and are subject to change. Dimensions are case width and do not include for handles/terminals and switches.

BPS BOXER PACKAGED SOLUTIONS - HORIZONTAL UNIT 10 - PERFORMANCE & TECHNICAL INFORMATION

BPS 810H (ErP 2018) NOISE DATA FOR PLATE HEAT EXCHANGER UNITS

Plate Heat Exchanger		63	125	250	500	1000	2000	4000	8000	(dBA@3m)
Fan Code	Type									
B810H	Open Discharge	71	59	69	60	54	45	37	25	44
B810H	Open Intake	65	64	73	67	63	63	58	54	
B810H	Open Supply	71	68	78	79	81	79	75	71	
B810H	Open Extract	65	64	73	67	63	63	58	54	
B810H	Breakout	71	68	78	79	81	79	75	71	

BPS 810H PLATE HEAT EXCHANGER UNIT - EFFICIENCY

B810H HEAT EXCHANGER EFFICIENCY

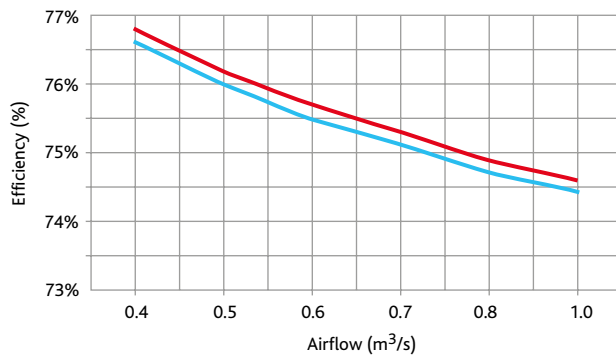

B810H HEAT EXCHANGER HEAT RECOVERY

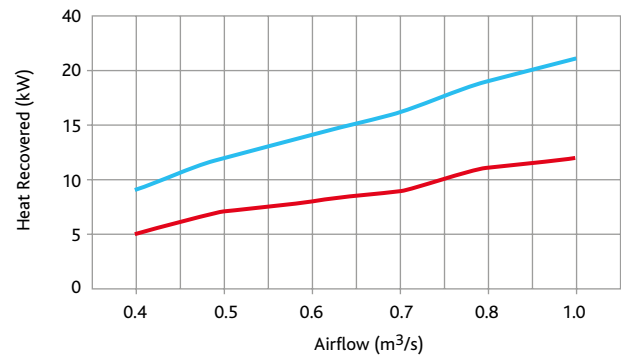

B810H HEAT EXCHANGER AIR-OFF TEMPERATURES

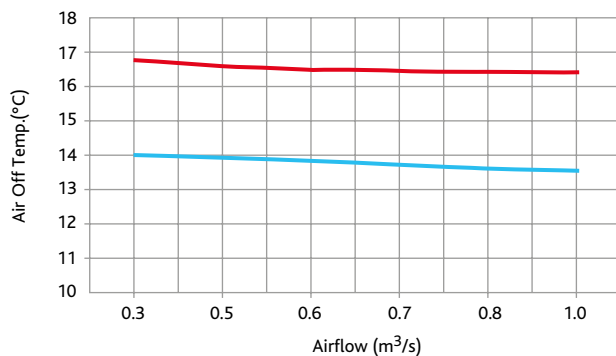

KEY:

- B810H @ 6°C Inlet
- B810H @ -5°C Inlet

All performance data based on indoor condition: 21°C @ 50% RH

BPS BOXER PACKAGED SOLUTIONS - HORIZONTAL UNIT 10 - COIL DATA

BPS B810H COIL DATA

UNIT CONFIGURATION		AIR INLET CONDITION		AIR CONDITION AFTER HX		WATER PARAMETERS		AIR CONDITION AFTER COIL		
Model Code	Airflow (m ³ /s)	Dry bulb (°C)	Relative Humidity (%)	Dry bulb (°C)	Relative Humidity (%)	Inlet temp. (°C)	Outlet temp. (°C)	Dry bulb (°C)	Relative Humidity (%)	
B810H/*R	1	28.0	42.9	22.8	58.3	-	-	15.5	79.1	
B810H/*R	1	10.0	70.0	18.1	41.2	-	-	30.0	20.1	
B810H/*C	1	28.0	42.9	22.8	58.3	6.0	12.0	15.5	79.1	
B810H/*C	1	28.0	42.9	22.8	58.3	8.0	14.0	15.5	79.1	
B810H/*C	1	28.0	42.9	22.8	58.3	10.0	16.0	16.3	76.3	
B810H/L*	1	10.0	70.0	18.1	41.2	82.0	71.0	30.0	20.1	
B810H/L*	1	10.0	70.0	18.1	41.2	80.0	60.0	30.0	20.1	
B810H/L*	1	10.0	70.0	18.1	41.2	60.0	40.0	30.0	20.1	
B810H/*R	0.75	28.0	42.9	22.7	58.5	-	-	15.5	79.1	
B810H/*R	0.75	10.0	70.0	18.2	41.0	-	-	30.0	20.1	
B810H/*C	0.75	28.0	42.9	22.7	58.5	6.0	12.0	15.6	78.9	
B810H/*C	0.75	28.0	42.9	22.7	58.5	8.0	14.0	15.6	78.9	
B810H/*C	0.75	28.0	42.9	22.7	58.5	10.0	16.0	16.6	74.8	
B810H/L*	0.75	10.0	70.0	18.2	41.0	82.0	71.0	30.0	20.1	
B810H/L*	0.75	10.0	70.0	18.2	41.0	80.0	60.0	30.0	20.1	
B810H/L*	0.75	10.0	70.0	18.2	41.0	60.0	40.0	30.0	20.1	
B810H/*R	0.5	28.0	42.9	22.7	58.8	-	-	15.5	79.1	
B810H/*R	0.5	10.0	70.0	18.3	40.7	-	-	30.0	20.1	
B810H/*C	0.5	28.0	42.9	22.7	58.8	6.0	12.0	15.5	79.1	
B810H/*C	0.5	28.0	42.9	22.7	58.8	8.0	14.0	15.9	78.0	
B810H/*C	0.5	28.0	42.9	22.7	58.8	10.0	16.0	17.0	73.7	
B810H/L*	0.5	10.0	70.0	18.3	40.7	82.0	71.0	30.0	20.1	
B810H/L*	0.5	10.0	70.0	18.3	40.7	80.0	60.0	30.0	20.1	
B810H/L*	0.5	10.0	70.0	18.3	40.7	60.0	40.0	30.0	20.1	

Note: performance is based on an indoor (or space, room etc.) condition of 21°C @ 50%RH.

	HX PERFORMANCE		DX COOLING		DX HEATING	CW COOLING		LPHW HEATING	UNIT PERFORMANCE			
	Free cooling (kW)	Heat recovery (kW)	Sensible (kW)	Gross (kW)	Capacity (kW)	Sensible (kW)	Gross (kW)	Capacity (kW)	Cooling (kW)	Heating (kW)	Water flow (l/s)	Coil Δp (kPa)
	6.2	-	8.8	10.5	-	-	-	-	15.0	-	-	-
	-	9.7	-	-	26.4	-	-	-	-	36.1	-	-
	6.2	-	-	-	-	8.8	9.9	-	15.0	-	0.394	11.5
	6.2	-	-	-	-	8.8	9.7	-	15.0	-	0.384	10.9
	6.2	-	-	-	-	7.8	9.3	-	14.0	-	0.371	10.1
	-	9.7	-	-	-	-	-	14.8	-	24.6	0.33	11.9
	-	9.7	-	-	-	-	-	14.8	-	24.6	0.181	4.1
	-	9.7	-	-	-	-	-	14.8	-	24.5	0.18	4.3
	4.8	-	6.5	7.8	-	-	-	-	11.3	-	-	-
	-	7.4	-	-	21.7	-	-	-	-	29.1	-	-
	4.8	-	-	-	-	6.4	7.8	-	11.2	-	0.308	7.3
	4.8	-	-	-	-	6.4	7.6	-	11.2	-	0.301	6.9
	4.8	-	-	-	-	5.5	7.3	-	10.3	-	0.292	6.5
	-	7.4	-	-	-	-	-	10.9	-	18.3	0.243	7
	-	7.4	-	-	-	-	-	10.9	-	18.3	0.133	2.3
	-	7.4	-	-	-	-	-	10.9	-	18.3	0.133	2.4
	3.2	-	4.3	5.2	-	-	-	-	7.5	-	-	-
	-	5.0	-	-	16.3	-	-	-	-	21.3	-	-
	3.2	-	-	-	-	4.3	5.2	-	7.5	-	0.207	3.5
	3.2	-	-	-	-	4.1	5.1	-	7.3	-	0.202	3.3
	3.2	-	-	-	-	3.4	4.9	-	6.6	-	0.196	3.2
	-	5.0	-	-	-	-	-	7.2	-	12.2	0.161	3.3
	-	5.0	-	-	-	-	-	7.2	-	12.2	0.088	1.1
	-	5.0	-	-	-	-	-	7.2	-	12.2	0.088	1.118.3

BPS BOXER PACKAGED SOLUTIONS - HORIZONTAL UNIT 15 - PERFORMANCE & TECHNICAL INFORMATION

BPS B815H PERFORMANCE FOR PLATE HEAT EXCHANGER UNIT

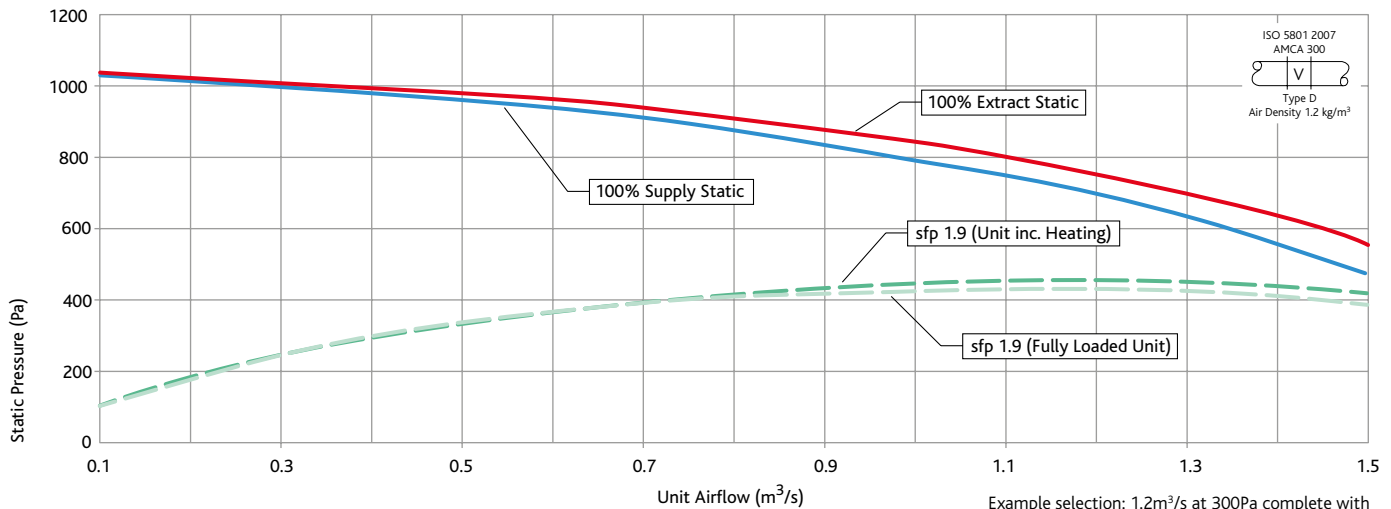

BPS B815H TECHNICAL INFORMATION

Unit Code	Voltage / Phase / Frequency	FLC (A)	Max Operating Temperature	Fan Speed (rpm)	Unit Weight (kg)	Intake Exhaust Module	PHX Module	Supply Exhaust Module	Electric Heater Module
B815H/LR/**-#	400 / 3 / 50	11.3	40°C	2180	1436	290	752	468	-
B815H/LC/**-#	400 / 3 / 50	6.8	40°C	2180	1436	290	752	468	-
B815H/LN/**-#	400 / 3 / 50	6.8	40°C	2180	1389	290	752	421	-
B815H/ER/**-#	400 / 3 / 50	11.3+35*	40°C	2180	1689	290	752	439	282
B815H/EC/**-#	400 / 3 / 50	6.8+35*	40°C	2180	1689	290	752	439	282
B815H/EN/**-#	400 / 3 / 50	6.8+35*	40°C	2180	1642	290	752	392	282
B815H/NR/**-#	400 / 3 / 50	11.3	40°C	2180	1407	290	752	439	-
B815H/NC/**-#	400 / 3 / 50	6.8	40°C	2180	1407	290	752	439	-
B815H/NN/**-#	400 / 3 / 50	6.8	40°C	2180	1360	290	752	392	-

** Add relevant control option. i.e AT, CO, ES.

Add relevant handing. i.e L (Left) R (Right).

*FLC: Includes separate supply for a 24kW Heater element.

Please note: All weights displayed are estimated weights and are subject to change.
Dimensions are case width and do not include for handles/terminals and switches.

Unit Code	PALLET CRATE DIMENSIONS (mm)			
	Intake / Exhaust Module	PHX Module	Supply / Exhaust Module	Electric / Heater Module
B815H/LR/**-#	950L x 2450W x 1420H	2450L x 2450W x 1420H	1350L x 2450W x 1420H	-
B815H/LC/**-#	950L x 2450W x 1420H	2450L x 2450W x 1420H	1350L x 2450W x 1420H	-
B815H/LN/**-#	950L x 2450W x 1420H	2450L x 2450W x 1420H	1350L x 2450W x 1420H	-
B815H/ER/**-#	950L x 2450W x 1420H	2450L x 2450W x 1420H	1350L x 2450W x 1420H	950L x 2450W x 1420H
B815H/EC/**-#	950L x 2450W x 1420H	2450L x 2450W x 1420H	1350L x 2450W x 1420H	950L x 2450W x 1420H
B815H/EN/**-#	950L x 2450W x 1420H	2450L x 2450W x 1420H	1350L x 2450W x 1420H	950L x 2450W x 1420H
B815H/NR/**-#	950L x 2450W x 1420H	2450L x 2450W x 1420H	1350L x 2450W x 1420H	-
B815H/NC/**-#	950L x 2450W x 1420H	2450L x 2450W x 1420H	1350L x 2450W x 1420H	-
B815H/NN/**-#	950L x 2450W x 1420H	2450L x 2450W x 1420H	1350L x 2450W x 1420H	-

** Add relevant control option. i.e AT, CO, ES.

Add relevant handing. i.e L (Left) R (Right).

*FLC: Includes separate supply for a 24kW Heater element.

Please note: All weights displayed are estimated weights and are subject to change.
Dimensions are case width and do not include for handles/terminals and switches.

BPS BOXER PACKAGED SOLUTIONS - HORIZONTAL UNIT 15 - PERFORMANCE & TECHNICAL INFORMATION

BPS B815H (ErP 2018) NOISE DATA FOR PLATE HEAT EXCHANGER UNIT

Plate Heat Exchanger										
Fan Code	Type	63	125	250	500	1000	2000	4000	8000	(dBA@3m)
B815H	Open Discharge	71	60	70	60	56	43	35	23	45
B815H	Open Intake	65	63	73	68	66	61	56	52	
B815H	Open Supply	71	69	80	80	83	77	72	68	
B815H	Open Extract	65	63	73	68	66	61	56	52	
B815H	Breakout	71	69	80	80	83	77	72	68	

BPS B815H PLATE HEAT EXCHANGER UNIT - EFFICIENCY

B815H HEAT EXCHANGER EFFICIENCY

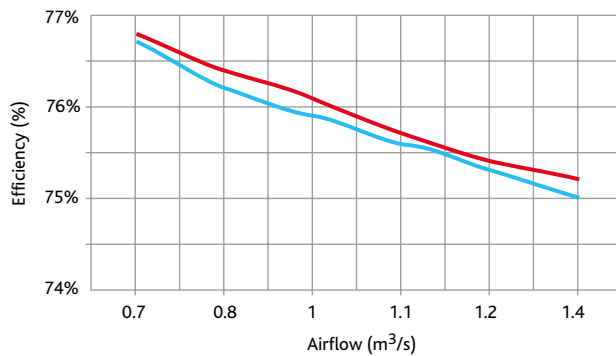

B815H HEAT EXCHANGER HEAT RECOVERY

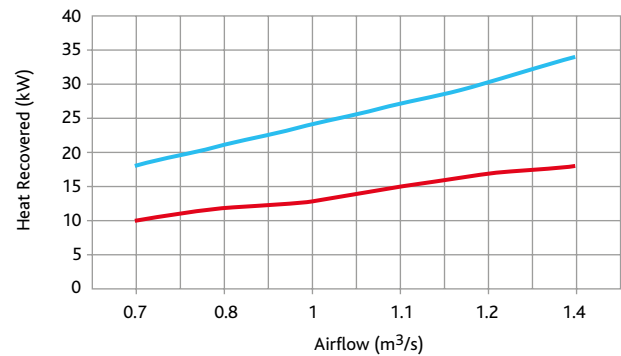

B815H HEAT EXCHANGER AIR-OFF TEMPERATURES

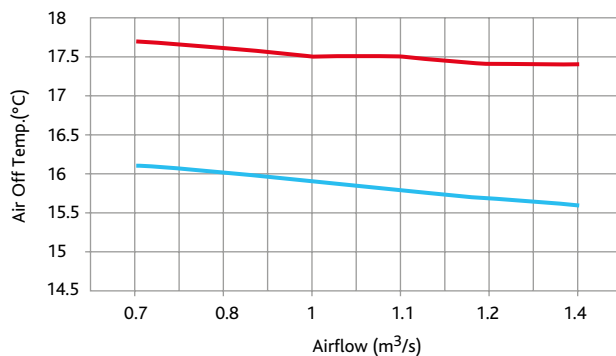

KEY:

- B815H @ 6°C Inlet
- B815H @ -5°C Inlet

All performance data based on indoor condition: 21°C @ 50% RH

BPS BOXER PACKAGED SOLUTIONS - HORIZONTAL UNIT 15 - COIL DATA

BPS B815H COIL DATA

UNIT CONFIGURATION		AIR INLET CONDITION		AIR CONDITION AFTER HX		WATER PARAMETERS		AIR CONDITION AFTER COIL	
Model Code	Airflow (m³/s)	Dry bulb (°C)	Relative Humidity (%)	Dry bulb (°C)	Relative Humidity (%)	Inlet temp. (°C)	Outlet temp. (°C)	Dry bulb (°C)	Relative Humidity (%)
B815H/*R	1.5	28.0	42.9	22.8	58.4	-	-	15.5	79.1
B815H/*R	1.5	10.0	70.0	18.7	39.9	-	-	30.0	20.1
B815H/*C	1.5	28.0	42.9	22.8	58.4	6.0	12.0	15.5	79.1
B815H/*C	1.5	28.0	42.9	22.8	58.4	8.0	14.0	15.5	79.1
B815H/*C	1.5	28.0	42.9	22.8	58.4	10.0	16.0	16.3	76.3
B815H/L*	1.5	10.0	70.0	18.1	39.9	82.0	71.0	30.0	20.1
B815H/L*	1.5	10.0	70.0	18.1	39.9	80.0	60.0	30.0	20.1
B815H/L*	1.5	10.0	70.0	18.1	39.9	60.0	40.0	30.0	20.1
B815H/*R	1.125	28.0	42.9	22.6	59.2	-	-	15.5	79.1
B815H/*R	1.125	10.0	70.0	18.8	39.6	-	-	30.0	20.1
B815H/*C	1.125	28.0	42.9	22.6	59.2	6.0	12.0	15.6	78.9
B815H/*C	1.125	28.0	42.9	22.6	59.2	8.0	14.0	15.6	78.9
B815H/*C	1.125	28.0	42.9	22.6	59.2	10.0	16.0	16.6	74.8
B815H/L*	1.125	10.0	70.0	18.8	39.6	82.0	71.0	30.0	20.1
B815H/L*	1.125	10.0	70.0	18.8	39.6	80.0	60.0	30.0	20.1
B815H/L*	1.125	10.0	70.0	18.8	39.6	60.0	40.0	30.0	20.1
B815H/*R	0.75	28.0	42.9	22.5	59.4	-	-	15.5	79.1
B815H/*R	0.75	10.0	70.0	18.9	39.3	-	-	30.0	20.1
B815H/*C	0.75	28.0	42.9	22.5	59.4	6.0	12.0	15.5	79.1
B815H/*C	0.75	28.0	42.9	22.5	59.4	8.0	14.0	15.9	78.0
B815H/*C	0.75	28.0	42.9	22.5	59.4	10.0	16.0	17.0	73.7
B815H/L*	0.75	10.0	70.0	18.9	39.3	82.0	71.0	30.0	20.1
B815H/L*	0.75	10.0	70.0	18.9	39.3	80.0	60.0	30.0	20.1
B815H/L*	0.75	10.0	70.0	18.9	39.3	60.0	40.0	30.0	20.1

Note: performance is based on an indoor (or space, room etc.) condition of 21°C @ 50%RH.

	HX PERFORMANCE		DX COOLING		DX HEATING	CW COOLING		LPHW HEATING	UNIT PERFORMANCE			
	Free cooling (kW)	Heat recovery (kW)	Sensible (kW)	Gross (kW)	Capacity (kW)	Sensible (kW)	Gross (kW)	Capacity (kW)	Cooling (kW)	Heating (kW)	Water flow (l/s)	Coil Δp (kPa)
	9.4	-	13.1	15.0	-	-	-	-	22.5	-	-	-
	-	15.7	-	-	26.4	-	-	-	-	42.1	-	-
	9.4	-	-	-	-	13.1	15.3	-	22.5	-	0.625	5.12
	9.4	-	-	-	-	13.1	15.3	-	22.5	-	0.61	4.83
	9.4	-	-	-	-	11.7	12.7	-	21.1	-	0.503	3.35
		14.6	-	-	-	-	-	21.6	-	36.2	0.482	5.96
		14.6	-	-	-	-	-	21.6	-	36.2	0.265	3.32
		14.6	-	-	-	-	-	21.6	-	36.2	0.263	2.04
	7.3	-	9.6	15.0	-	-	-	-	16.9	-	-	-
	-	11.9	-	-	21.7	-	-	-	-	33.6	-	-
	7.3	-	-	-	-	9.5	11.8	-	16.7	-	0.469	3
	7.3	-	-	-	-	9.5	11.5	-	16.7	-	0.458	2.85
	7.3	-	-	-	-	8.1	9.0	-	15.4	-	0.356	1.74
	-	11.9	-	-	-	-	-	16.1	-	28.0	0.359	3.46
		11.9	-	-	-	-	-	16.1	-	28.0	0.197	1.18
		11.9	-	-	-	-	-	16.1	-	28.0	0.197	1.18
	5.0	-	6.3	15.0	-	-	-	-	11.3	-	-	-
	-	8.0	-	-	16.3	-	-	-	-	24.3	-	-
	5.0	-	-	-	-	6.3	7.8	-	11.3	-	0.309	1.27
	5.0	-	-	-	-	6.0	7.1	-	10.9	-	0.28	0.98
	5.0	-	-	-	-	5.0	5.5	-	9.9	-	0.218	0.66
	-	8.0	-	-	-	-	-	10.7	-	18.7	0.237	1.62
	-	8.0	-	-	-	-	-	10.7	-	18.7	0.13	0.55
	-	8.0	-	-	-	-	-	10.7	-	18.7	0.129	0.59

BPS BOXER PACKAGED SOLUTIONS - HORIZONTAL UNIT 20 - PERFORMANCE & TECHNICAL INFORMATION

BPS B820H PERFORMANCE FOR PLATE HEAT EXCHANGER UNIT

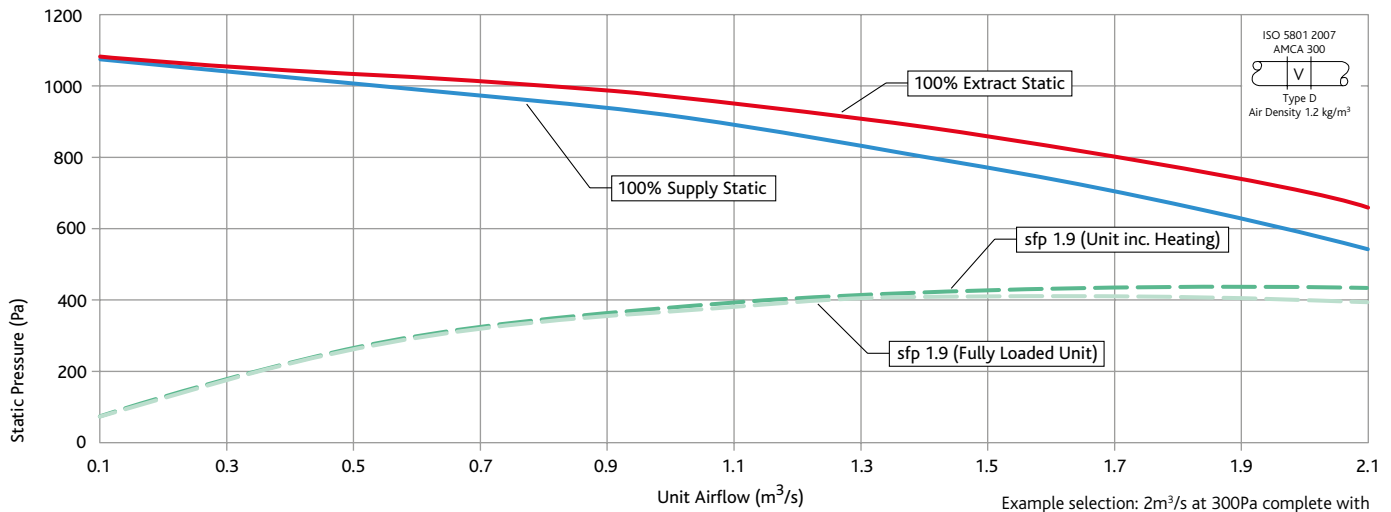

Example selection: 2m³/s at 300Pa complete with 2018 Plate Heat Exchanger, LPHW heater, Reverse cycle coil, Connect control, SFP = 1.6 W/(l/s)

BPS B820H TECHNICAL INFORMATION

Unit Code	Voltage / Phase / Frequency	FLC (A)	Max Operating Temperature	Fan Speed (rpm)	Unit Weight (kg)	Intake Exhaust Module	PHX Module	Supply Exhaust Module	Electric Heater Module
B820H/LR/**-#	400 / 3 / 50	14.1	40°C	1780	1877	342	986	549	-
B820H/LC/**-#	400 / 3 / 50	9.6	40°C	1780	1877	342	986	549	-
B820H/LN/**-#	400 / 3 / 50	9.6	40°C	1780	1821	342	986	493	-
B820H/ER/**-#	400 / 3 / 50	14.1+53*	40°C	1780	2188	342	986	518	342
B820H/EC/**-#	400 / 3 / 50	9.6+53*	40°C	1780	2188	342	986	518	342
B820H/EN/**-#	400 / 3 / 50	9.6+53*	40°C	1780	2132	342	986	462	342
B820H/NR/**-#	400 / 3 / 50	14.1	40°C	1780	1846	342	986	518	-
B820H/NC/**-#	400 / 3 / 50	9.6	40°C	1780	1846	342	986	518	-
B820H/NN/**-#	400 / 3 / 50	9.6	40°C	1780	1790	342	986	462	-

** Add relevant control option. i.e AT, CO, ES.

Add relevant handing. i.e L (Left) R (Right).

*FLC: Includes separate supply for a 36kW Heater element.

Please note: All weights displayed are estimated weights and are subject to change. Dimensions are case width and do not include for handles/terminals and switches.

Unit Code	PALLET CRATE DIMENSIONS (mm)			
	Intake / Exhaust Module	PHX Module	Supply / Exhaust Module	Electric / Heater Module
B820H/LR/**-#	950L x 2850W x 1420H	2850L x 2850W x 1420H	1350L x 2850W x 1420H	-
B820H/LC/**-#	950L x 2850W x 1420H	2850L x 2850W x 1420H	1350L x 2850W x 1420H	-
B820H/LN/**-#	950L x 2850W x 1420H	2850L x 2850W x 1420H	1350L x 2850W x 1420H	-
B820H/ER/**-#	950L x 2850W x 1420H	2850L x 2850W x 1420H	1350L x 2850W x 1420H	950L x 2850W x 1420H
B820H/EC/**-#	950L x 2850W x 1420H	2850L x 2850W x 1420H	1350L x 2850W x 1420H	950L x 2850W x 1420H
B820H/EN/**-#	950L x 2850W x 1420H	2850L x 2850W x 1420H	1350L x 2850W x 1420H	950L x 2850W x 1420H
B820H/NR/**-#	950L x 2850W x 1420H	2850L x 2850W x 1420H	1350L x 2850W x 1420H	-
B820H/NC/**-#	950L x 2850W x 1420H	2850L x 2850W x 1420H	1350L x 2850W x 1420H	-
B820H/NN/**-#	950L x 2850W x 1420H	2850L x 2850W x 1420H	1350L x 2850W x 1420H	-

** Add relevant control option. i.e AT, CO, ES.

Add relevant handing. i.e L (Left) R (Right).

*FLC: Includes separate supply for a 36kW Heater element.

Please note: All weights displayed are estimated weights and are subject to change. Dimensions are case width and do not include for handles/terminals and switches.

BPS BOXER PACKAGED SOLUTIONS - HORIZONTAL UNIT 20 - PERFORMANCE & TECHNICAL INFORMATION

BPS B820H (ErP 2018) NOISE DATA FOR PLATE HEAT EXCHANGER UNITS

Plate Heat Exchanger										
Fan Code	Type	63	125	250	500	1000	2000	4000	8000	(dBA@3m)
B820H	Open Discharge	72	69	69	63	53	43	35	41	46
B820H	Open Intake	66	67	76	69	66	65	61	58	
B820H	Open Supply	72	76	80	80	83	77	72	68	
B820H	Open Extract	66	67	76	69	66	65	61	58	
B820H	Breakout	72	76	80	80	83	77	72	68	

BPS B820H PLATE HEAT EXCHANGER UNITS - EFFICIENCY

B820H HEAT EXCHANGER EFFICIENCY

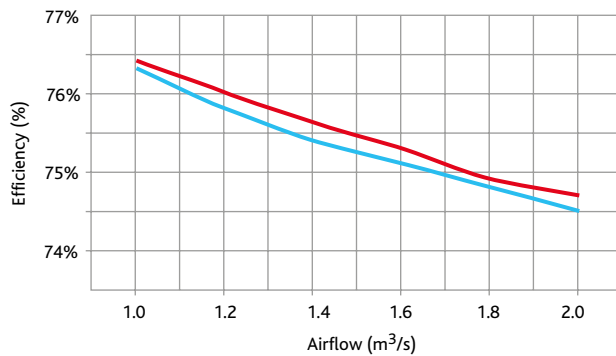

B820H HEAT EXCHANGER HEAT RECOVERY

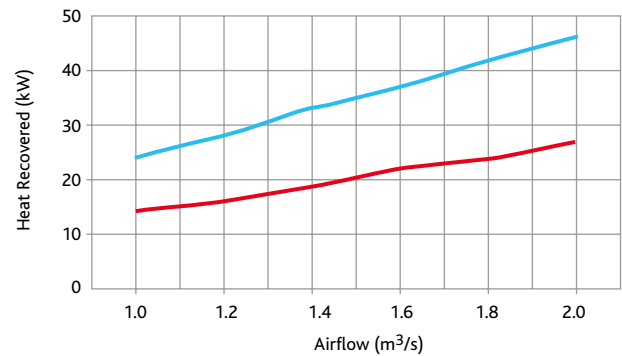

B820H HEAT EXCHANGER AIR-OFF TEMPERATURES

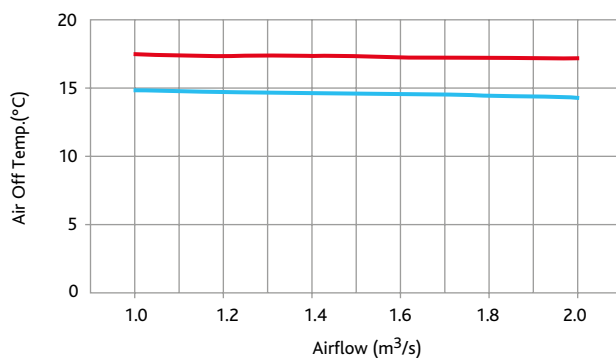

KEY:

- B820H @ 6°C Inlet
- B820H @ -5°C Inlet

All performance data based on indoor condition: 21°C @ 50% RH

BPS BOXER PACKAGED SOLUTIONS - HORIZONTAL UNIT 20 - COIL DATA

BPS B820H COIL DATA

UNIT CONFIGURATION		AIR INLET CONDITION		AIR CONDITION AFTER HX		WATER PARAMETERS		AIR CONDITION AFTER COIL		
Model Code	Airflow (m ³ /s)	Dry bulb (°C)	Relative Humidity (%)	Dry bulb (°C)	Relative Humidity (%)	Inlet temp. (°C)	Outlet temp. (°C)	Dry bulb (°C)	Relative Humidity (%)	
B820H/*R	2	28.0	42.9	22.8	58.4	-	-	15.5	79.1	
B820H/*R	2	10.0	70.0	18.7	39.9	-	-	30.0	20.1	
B820H/*C	2	28.0	42.9	22.8	58.4	6.0	12.0	15.5	79.1	
B820H/*C	2	28.0	42.9	22.8	58.4	8.0	14.0	15.5	79.1	
B820H/*C	2	28.0	42.9	22.8	58.4	10.0	16.0	16.3	76.3	
B820H/L*	2	10.0	70.0	18.1	39.9	82.0	71.0	30.0	20.1	
B820H/L*	2	10.0	70.0	18.1	39.9	80.0	60.0	30.0	20.1	
B820H/L*	2	10.0	70.0	18.1	39.9	60.0	40.0	30.0	20.1	
B820H/*R	1.5	28.0	42.9	22.6	59.2	-	-	15.5	79.1	
B820H/*R	1.5	10.0	70.0	18.8	39.6	-	-	30.0	20.1	
B820H/*C	1.5	28.0	42.9	22.6	59.2	6.0	12.0	15.6	78.9	
B820H/*C	1.5	28.0	42.9	22.6	59.2	8.0	14.0	15.6	78.9	
B820H/*C	1.5	28.0	42.9	22.6	59.2	10.0	16.0	16.6	74.8	
B820H/L*	1.5	10.0	70.0	18.8	39.6	82.0	71.0	30.0	20.1	
B820H/L*	1.5	10.0	70.0	18.8	39.6	80.0	60.0	30.0	20.1	
B820H/L*	1.5	10.0	70.0	18.8	39.6	60.0	40.0	30.0	20.1	
B820H/*R	1	28.0	42.9	22.5	59.4	-	-	15.5	79.1	
B820H/*R	1	10.0	70.0	18.9	39.3	-	-	30.0	20.1	
B820H/*C	1	28.0	42.9	22.5	59.4	6.0	12.0	15.5	79.1	
B820H/*C	1	28.0	42.9	22.5	59.4	8.0	14.0	15.9	78.0	
B820H/*C	1	28.0	42.9	22.5	59.4	10.0	16.0	17.0	73.720.1	
B820H/L*	1	10.0	70.0	18.9	39.3	82.0	71.0	30.0	20.1	
B820H/L*	1	10.0	70.0	18.9	39.3	80.0	60.0	30.0	20.1	
B820H/L*	1	10.0	70.0	18.9	39.3	60.0	40.0	30.0	20.1	

Note: performance is based on an indoor (or space, room etc.) condition of 21°C @ 50%RH.

	HX PERFORMANCE		DX COOLING		DX HEATING	CW COOLING		LPHW HEATING	UNIT PERFORMANCE			
	Free cooling (kW)	Heat recovery (kW)	Sensible (kW)	Gross (kW)	Capacity (kW)	Sensible (kW)	Gross (kW)	Capacity (kW)	Cooling (kW)	Heating (kW)	Water flow (l/s)	Coil Δp (kPa)
	12.5	-	17.5	19.3	-	-	-	-	30.0	-	-	-
	-	20.9	-	-	26.4	-	-	-	-	47.3	-	-
	12.5	-	-	-	-	17.5	21.1	-	30.0	-	0.835	6.4
	12.5	-	-	-	-	17.5	20.5	-	30.0	-	0.815	7
	12.5	-	-	-	-	15.6	19.9	-	28.1	-	0.791	6.6
		19.4	-	-	-	-	-	29.2	-	48.6	0.649	11.9
		19.4	-	-	-	-	-	29.2	-	48.6	0.356	4.2
		19.4	-	-	-	-	-	29.2	-	48.6	0.353	4.3
	9.7	-	12.8	15.8	-	-	-	-	22.5	-	-	-
	-	15.8	-	-	21.7	-	-	-	-	37.5	-	-
	9.7	-	-	-	-	12.6	15.8	-	22.3	-	0.629	4.3
	9.7	-	-	-	-	12.6	15.4	-	22.3	-	0.612	4.1
	9.7	-	-	-	-	10.8	14.9	-	20.5	-	0.593	3.8
	-	15.8	-	-	-	-	-	21.9	-	37.7	0.487	7.3
	-	15.8	-	-	-	-	-	21.9	-	37.7	0.267	2.4
	-	15.8	-	-	-	-	-	21.9	-	37.7	0.265	2.5
	6.6	-	8.4	9.6	-	-	-	-	15.0	-	-	-
	-	10.7	-	-	16.3	-	-	-	-	27.0	-	-
	6.6	-	-	-	-	8.4	10.4	-	15.0	-	0.413	2.1
	6.6	-	-	-	-	8.0	10.2	-	14.6	-	0.403	2
	6.6	-	-	-	-	6.6	9.8	-	13.2	-	0.391	1.8
	-	10.7	-	-	-	-	-	14.6	-	25.3	0.324	3.5
	-	10.7	-	-	-	-	-	14.6	-	25.3	0.178	1.2
	-	10.7	-	-	-	-	-	14.6	-	25.3	0.177	1.3

BPS BOXER PACKAGED SOLUTIONS - HORIZONTAL UNITS - HANDINGS & AIRFLOW

BPS HORIZONTAL PLATE HEAT EXCHANGER UNIT



▲ Model shown is left hand.

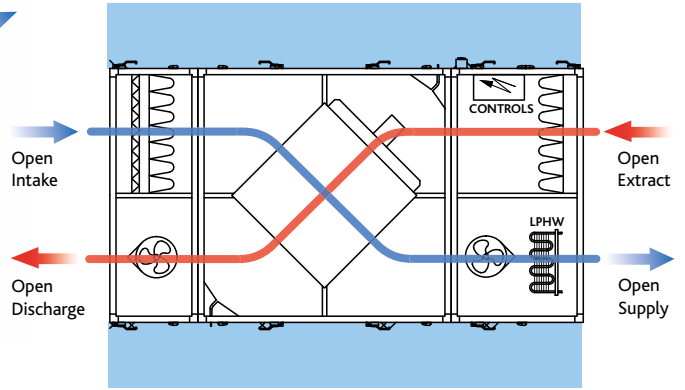

▲ Shown from top (left hand -L).



▲ Model shown is right hand.

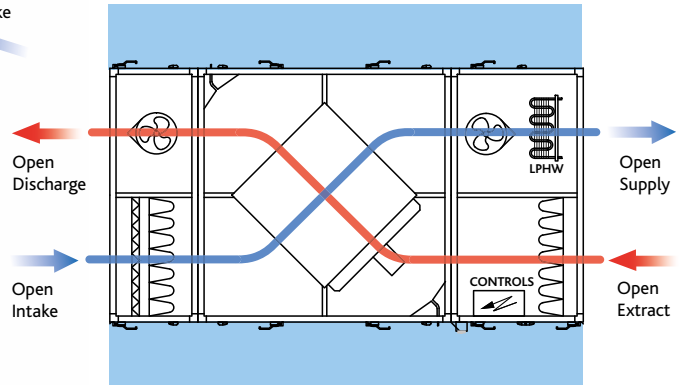

▲ Shown from top (right hand -R).

BPS BOXER PACKAGED SOLUTIONS - HORIZONTAL UNITS - DIMENSIONS

BPS DIMENSIONS FOR HORIZONTAL PLATE HEAT EXCHANGER UNIT (mm)

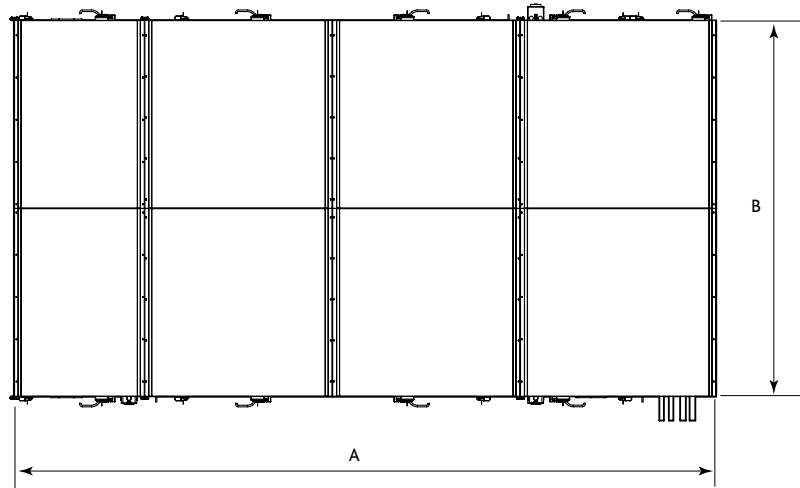
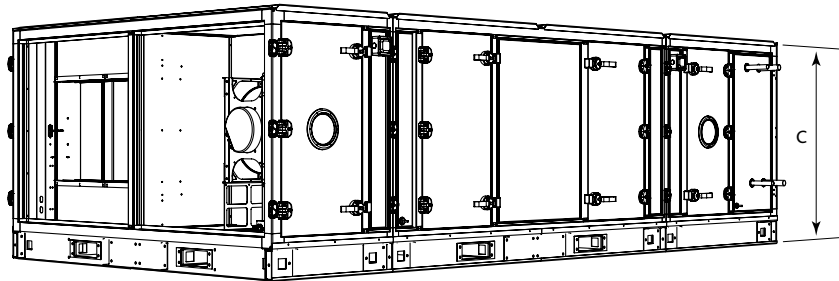

▲ Model shown is left hand.

Plate Heat Exchanger		A	A*	B	C
Model	Unit				
Plate HX	05	3750	4500	1750	850
Plate HX	10	4000	4750	2000	1050
Plate HX	15	4300	5050	2300	1300
Plate HX	20	4700	5450	2700	1300

*Electric Heater is included.
Dimension 'A' is for LPHW or No heating.

For product weights refer to performance and technical data pages.

BPS BOXER PACKAGED SOLUTIONS - HORIZONTAL UNITS - ANCILLARY OPTIONS (Based on left hand version)

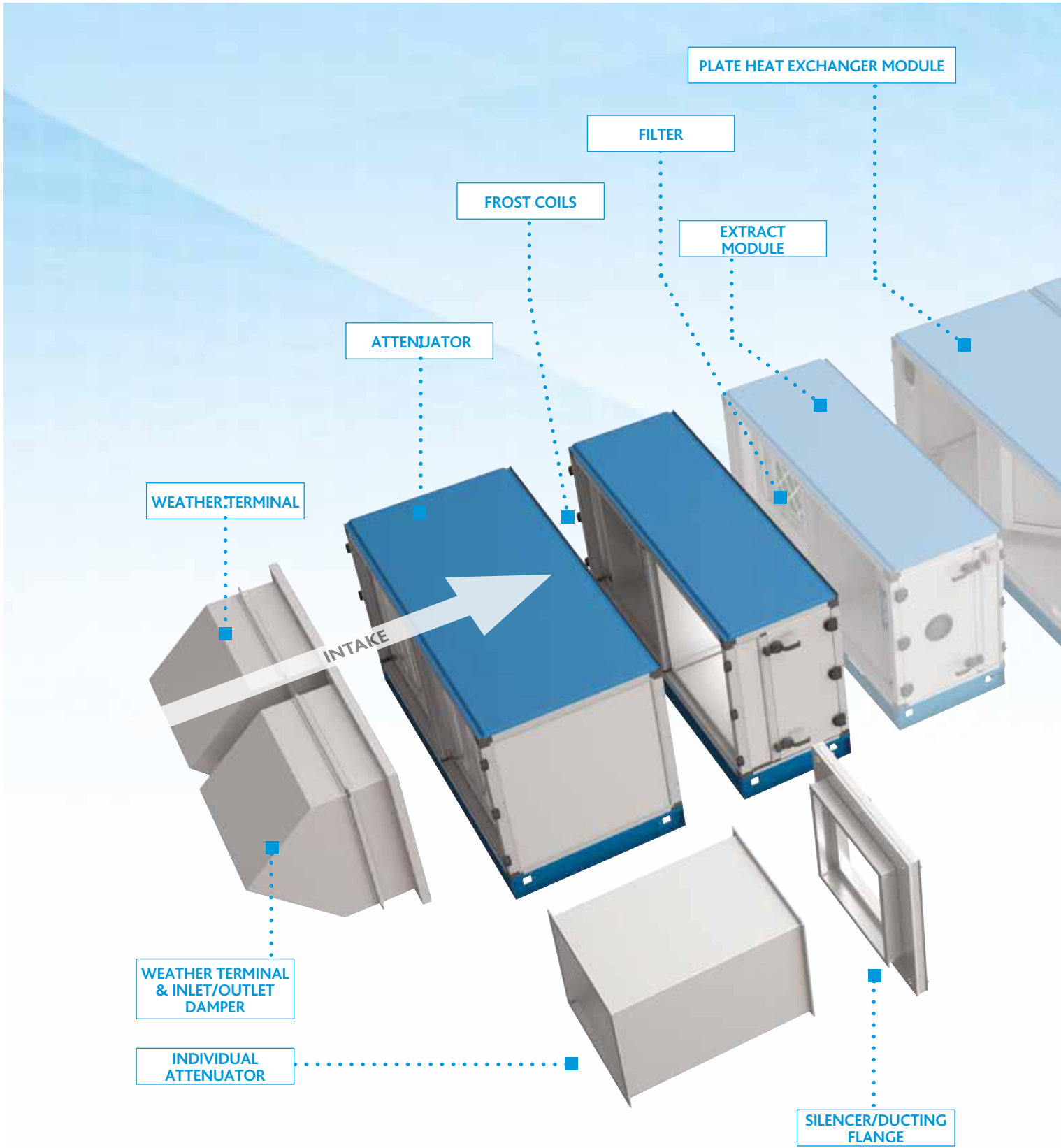

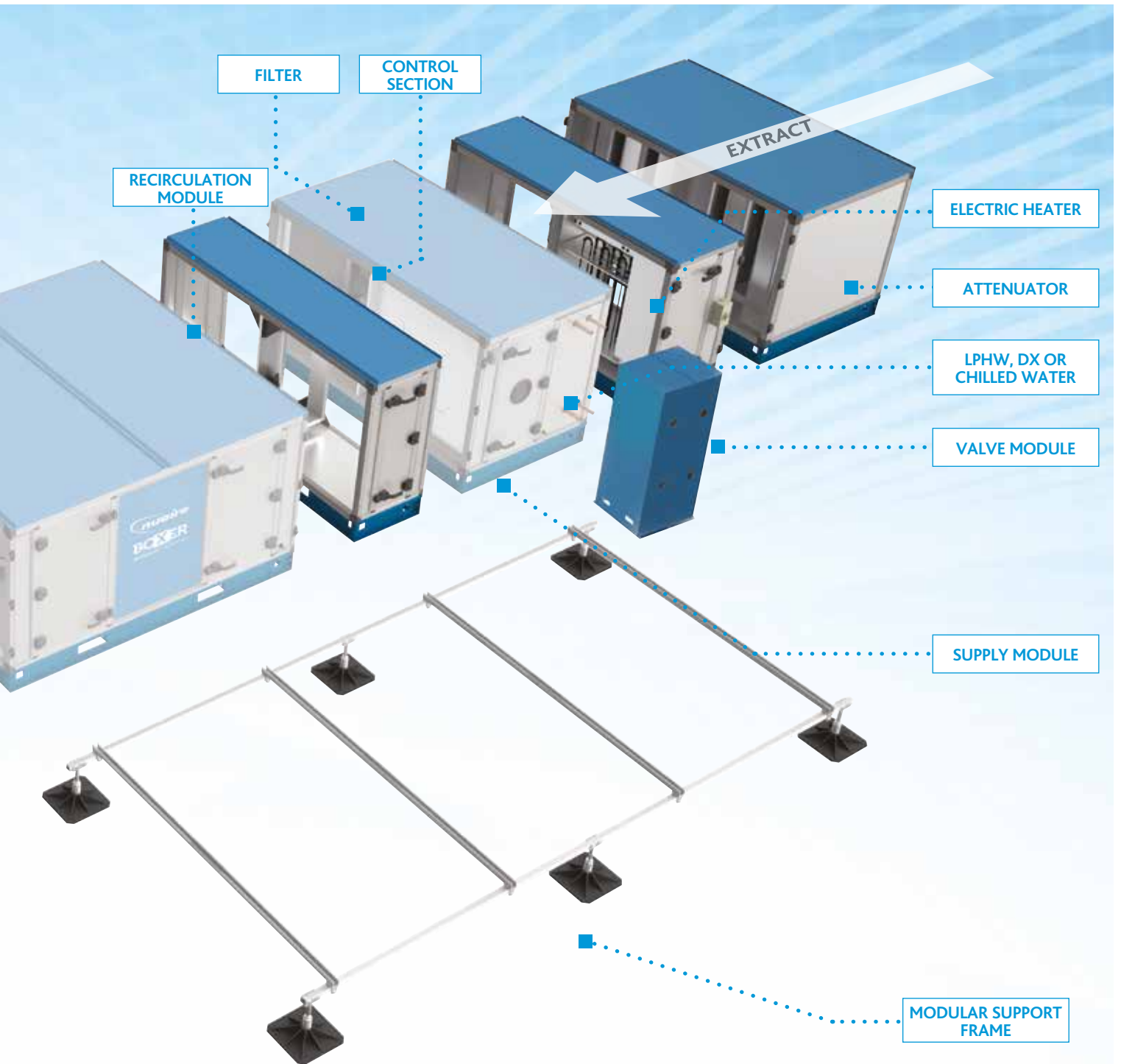

A full list of ancillaries, codes and dimensions for horizontal units can be found on pages 32 - 35.



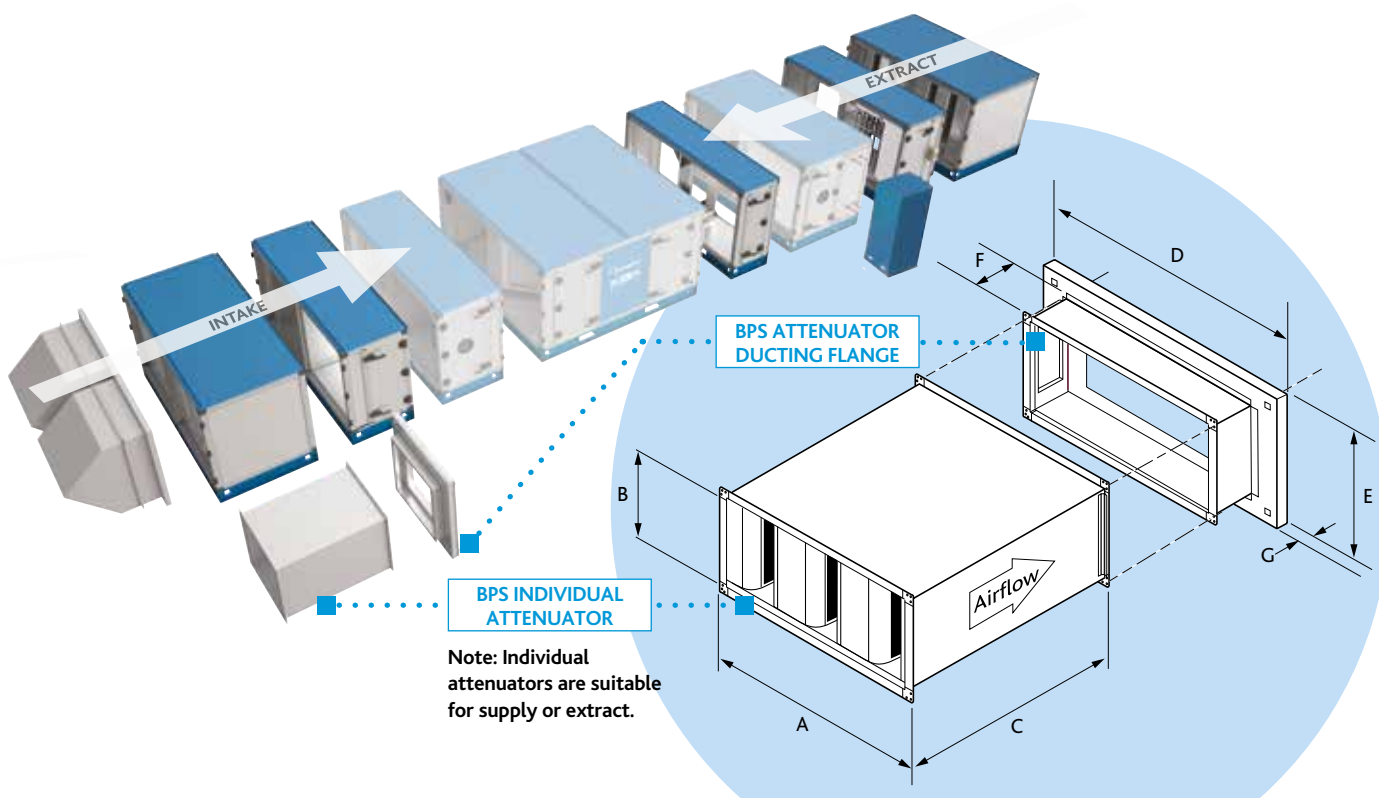

BPS BOXER PACKAGED SOLUTIONS - HORIZONTAL UNITS - ANCILLARY DETAILS & DIMENSIONS (mm)

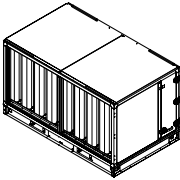
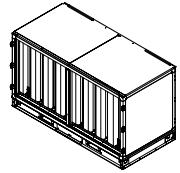
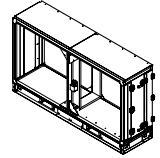

INDIVIDUAL BPS HORIZONTAL ATTENUATOR DIMENSIONS (mm), WEIGHTS (kg) & INSERTION LOSS (dB)															
Part Number	Description	A. Width	B. Height	C. Length	Weight (kg)	Vol (m ³ /s)	PL (Pa)	Attenuator Insertion loss							
								63	125	250	500	1k	2k	4k	8k
B05A/H-900	BPS size 05 attenuator 900mm length. Suitable for supply or extract. (Use with BPS attenuator flange, one per attenuator B05AH/F)	588	385	900	35	0.3	15	6	9	18	36	38	29	21	17
B05A/H-1200	BPS size 05 attenuator 1200mm length. Suitable for supply or extract. (Use with BPS attenuator flange, one per attenuator B05AH/F)	588	385	1200	44	0.3	16	8	11	22	44	48	38	25	19
B10A/H-900	BPS size 10 attenuator 900mm length. Suitable for supply or extract. (Use with BPS attenuator flange, one per attenuator B10AH/F)	708	577	900	57	1	26	5	7	13	28	38	27	18	14
B10A/H-1200	BPS size 10 attenuator 1200mm length. Suitable for supply or extract. (Use with BPS attenuator flange, one per attenuator B10AH/F)	708	577	1200	71	1	28	6	9	17	34	48	35	23	18
B15A/H-900	BPS size 15 attenuator 900mm length. Suitable for supply or extract. (Use with BPS attenuator flange, one per attenuator B15AH/F)	852	817	900	84	1.3	20	5	7	14	29	40	29	20	15
B15A/H-1200	BPS size 15 attenuator 1200mm length. Suitable for supply or extract. (Use with BPS attenuator flange, one per attenuator B15AH/F)	852	817	1200	106	1.3	22	7	10	18	35	50	38	25	19
B20A/H-900	BPS size 20 attenuator 900mm length. Suitable for supply or extract. (Use with BPS attenuator flange, one per attenuator B20AH/F)	1052	817	900	96	1.8	25	5	7	14	29	40	29	20	15
B20A/H-1200	BPS size 20 attenuator 1200mm length. Suitable for supply or extract. (Use with BPS attenuator flange, one per attenuator B20AH/F)	1052	817	1200	121	1.8	27	7	10	18	35	50	38	25	19

INDIVIDUAL BPS HORIZONTAL ATTENUATOR DUCTING FLANGE DIMENSIONS (mm), WEIGHTS (kg)						
Part Number	Description	D. Width	E. Height	F. Depth	G. Depth	Weight (kg)
B05AH/F	BPS size 05 Matching flange for use with stand alone attenuators. One required per attenuator	792	582	204	53	12
B10AH/F	BPS size 10 Matching flange for use with stand alone attenuators. One required per attenuator	917	782	204	53	16
B15AH/F	BPS size 15 Matching flange for use with stand alone attenuators. One required per attenuator	1067	1032	204	53	20
B20AH/F	BPS size 20 Matching flange for use with stand alone attenuators. One required per attenuator	1267	1032	204	53	22

BPS BOXER PACKAGED SOLUTIONS - HORIZONTAL UNITS - ANCILLARY DETAILS & DIMENSIONS (mm)

BPS BOXER PACKAGED AHUs - HORIZONTAL ANCILLARY DETAILS & DIMENSIONS (mm)															
BPS Ancillary	Description	Part Number	Part			Weight (kg)	Z Factor	Attenuator Insertion loss							
			Width	Height	Length			63	125	250	500	1k	2k	4k	8k
ATTENUATOR (SUPPLY/EXTRACT) 	BPS size **, Attenuator for supply/exhaust side. Right handed. For horizontal PHX units.	B05AH/AR900-R	1750	850	1350	440	92.00	5	9	16	33	45	38	25	21
		B10AH/AR900-R	2000	1050	1350	510	28.00	6	9	19	38	43	35	24	20
		B15AH/AR900-R	2300	1300	1350	580	9.77	5	9	16	32	45	36	25	20
		B20AH/AR900-R	2700	1300	1350	640	7.00	5	8	16	32	44	35	25	19
	BPS size **, Attenuator for supply/exhaust side. Left handed. For horizontal PHX units.	B05AH/AR900-L	1750	850	1350	440	92.00	5	9	16	33	45	38	25	21
		B10AH/AR900-L	2000	1050	1350	510	28.00	6	9	19	38	43	35	24	20
		B15AH/AR900-L	2300	1300	1350	580	9.77	5	9	16	32	45	36	25	20
		B20AH/AR900-L	2700	1300	1350	640	7.00	5	8	16	32	44	35	25	19
ATTENUATOR (INTAKE/EXHAUST) 	BPS size **, Attenuator for intake/exhaust side. Right handed. For horizontal PHX units.	B05AH/AA900-R	1750	850	1090	420	92.00	5	9	16	33	45	38	25	21
		B10AH/AA900-R	2000	1050	1090	470	28.00	6	9	19	38	43	35	24	20
		B15AH/AA900-R	2300	1300	1090	525	9.77	5	9	16	32	45	36	25	20
		B20AH/AA900-R	2700	1300	1090	540	7.00	5	8	16	32	44	35	25	19
	BPS size **, Attenuator for intake/exhaust side. Left handed. For horizontal PHX units.	B05AH/AA900-L	1750	850	1090	420	92.00	5	9	16	33	45	38	25	21
		B10AH/AA900-L	2000	1050	1090	470	28.00	6	9	19	38	43	35	24	20
		B15AH/AA900-L	2300	1300	1090	525	9.77	5	9	16	32	45	36	25	20
		B20AH/AA900-L	2700	1300	1090	540	7.00	5	8	16	32	44	35	25	19
RE-CIRCULATION MODULE 	BPS size **, Re-circulation Module. Right handed. For horizontal PHX units.	B05AH/RM-R	1750	850	600	148	-								
		B10AH/RM-R	2000	1050	600	165	-								
		B15AH/RM-R	2300	1300	600	195	-								
		B20AH/RM-R	2700	1300	600	210	-								
	BPS size **, Re-circulation Module. Left handed. For horizontal PHX units.	B05AH/RM-L	1750	850	600	148	-								
		B10AH/RM-L	2000	1050	600	165	-								
		B15AH/RM-L	2300	1300	600	195	-								
		B20AH/RM-L	2700	1300	600	210	-								
INLET/OUTLET DAMPER 	BPS size **, Inlet/outlet damper. Right handed. For horizontal PHX units.	B05AH/FD-R	790	580	255	14	31.29								
		B10AH/FD-R	920	780	255	18	8.28								
		B15AH/FD-R	1060	1030	255	20	2.58								
		B20AH/FD-R	1270	1030	255	22	1.62								
	BPS size **, Inlet/outlet damper. Left handed. For horizontal PHX units.	B05AH/FD-L	790	580	255	14	31.29								
		B10AH/FD-L	920	780	255	18	8.28								
		B15AH/FD-L	1060	1030	255	20	2.58								
		B20AH/FD-L	1270	1030	255	22	1.62								
ROOF TERMINAL 	BPS size **, Roof terminal. For horizontal PHX units.	B05AH/FRT	790	580	680	20	143.02								
		B10AH/FRT	920	780	780	30	49.99								
		B15AH/FRT	1060	1030	900	38	18.90								
		B20AH/FRT	1270	1030	900	42	12.73								
ROOF TERMINAL & DAMPER 	BPS size **, Roof terminal c/w damper. Right handed. For horizontal PHX units.	B05AH/FRTD-R	790	580	680	20	143.02								
		B10AH/FRTD-R	920	780	780	30	49.99								
		B15AH/FRTD-R	1060	1030	900	38	18.90								
		B20AH/FRTD-R	1270	1030	900	42	12.73								
	BPS size **, Roof terminal c/w damper. Left handed. For horizontal PHX units.	B05AH/FRTD-L	790	580	680	20	143.02								
		B10AH/FRTD-L	920	780	780	30	49.99								
		B15AH/FRTD-L	1060	1030	900	38	18.90								
		B20AH/FRTD-L	1270	1030	900	42	12.73								

** Insert either 05, 10, 15 or 20 for the relevant horizontal BPS unit.

BPS BOXER PACKAGED SOLUTIONS - HORIZONTAL UNITS - ANCILLARY DETAILS & DIMENSIONS (mm)

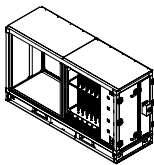
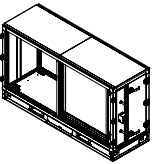
BPS BOXER PACKAGED AHUs - HORIZONTAL ANCILLARY DETAILS & DIMENSIONS (mm)									
BPS Ancillary	Description	Part Number	Width	Height	Length	Weight (kg)	Z Factor		
FROST COIL (ELECTRIC) 	BPS size **, 12kW.	B05AH/FE-R	1750	850	750	175	40.00		
	Frost coil electric. 18kW.	B10AH/FE-R	2000	1050	750	248	10.00		
	Right handed. 24kW.	B15AH/FE-R	2300	1300	750	285	2.22		
	For horizontal PHX units. 36kW.	B20AH/FE-R	2700	1300	750	310	1.25		
	BPS size **, 12kW.	B05AH/FE-L	1750	850	750	175	40.00		
	Frost coil electric. 18kW.	B10AH/FE-L	2000	1050	750	248	10.00		
FROST COIL (LPHW) 	Left handed. 24kW.	B15AH/FE-L	2300	1300	750	285	2.22		
	For horizontal PHX units. 36kW.	B20AH/FE-L	2700	1300	750	310	1.25		
	BPS size **, Right handed. Frost coil LPHW.	B05AH/FL-R	1750	850	750	175	36.00		
	For horizontal PHX units.	B10AH/FL-R	2000	1050	750	248	12.00		
		B15AH/FL-R	2300	1300	750	285	3.55		
		B20HV/FL-R	2700	1300	750	310	2.50		
	BPS size **, Left handed. Frost coil LPHW.	B05AH/FL-L	1750	850	750	175	36.00		
	For horizontal PHX units.	B10AH/FL-L	2000	1050	750	248	12.00		
		B15AH/FL-L	2300	1300	750	285	3.55		
		B20AH/FL-L	2700	1300	750	310	2.50		

FROST COIL DATA @ 100% SPEED

Part Number	Airflow (m³/s)	Water parameters		Ethyl Glycol %	Air Condition Dry bulb (°C)		Coil Duty (kW)	Water flow (l/s)	Coil Δp (kPa)
		Inlet temp. (°C)	Outlet temp. (°C)		Entering Coil	After Coil			
B05AH/FL-*	0.5	82	71	0	-10	5	9.02	0.201	11.8
	0.5	80	60	0	-10	5	9.02	0.11	4
	0.5	60	40	0	-10	5	9.02	0.109	4
B10AH/FL-*	1	82	71	0	-10	5	18.04	0.401	50.8
	1	80	60	0	-10	5	18.04	0.22	17.9
	1	60	40	0	-10	5	18.04	0.219	17.9
B15AH/FL-*	1.5	82	71	0	-10	5	27.1	0.6	31.9
	1.5	80	60	0	-10	5	27.1	0.33	10.8
	1.5	60	40	0	-10	5	27.1	0.33	10.2
B20AH/FL-*	2	82	71	0	-10	5	36.07	0.803	17.9
	2	80	60	0	-10	5	36.07	0.44	6.2
	2	60	40	0	-10	5	36.07	0.437	6.4

FROST COIL DATA @ 75% SPEED

B05AH/FL-*	0.375	82	71	0	-10	5	6.76	0.151	6.9
	0.375	80	60	0	-10	5	6.76	0.083	2.3
	0.375	60	40	0	-10	5	6.76	0.082	2.4
B10AH/FL-*	0.75	82	71	0	-10	5	13.5	0.301	30.6
	0.75	80	60	0	-10	5	13.5	0.165	10.3
	0.75	60	40	0	-10	5	13.5	0.164	10.5
B15AH/FL-*	1.125	82	71	0	-10	5	20.3	0.45	19
	1.125	80	60	0	-10	5	20.3	0.25	6.4
	1.125	60	40	0	-10	5	20.3	0.25	6.6
B20AH/FL-*	1.5	82	71	0	-10	5	27.05	0.602	10.9
	1.5	80	60	0	-10	5	27.05	0.33	3.6
	1.5	60	40	0	-10	5	27.05	0.328	3.8

FROST COIL DATA @ 50% SPEED

B05AH/FL-*	0.25	82	71	0	-10	5	4.51	0.1	4.3
	0.25	80	60	0	-10	5	4.51	0.055	1.1
	0.25	60	40	0	-10	5	4.51	0.055	1.1
B10AH/FL-*	0.5	82	71	0	-10	5	9.02	0.201	14.7
	0.5	80	60	0	-10	5	9.02	0.11	4.9
	0.5	60	40	0	-10	5	9.02	0.109	5.1
B15AH/FL-*	0.75	82	71	0	-10	5	13.5	0.3	9
	0.75	80	60	0	-10	5	13.5	0.17	3
	0.75	60	40	0	-10	5	13.5	0.16	3.2
B20AH/FL-*	1	82	71	0	-10	5	18.04	0.401	5.2
	1	80	60	0	-10	5	18.04	0.22	1.7
	1	60	40	0	-10	5	18.04	0.219	1.8

* insert L for left hand units and R for right hand units.

BPS BOXER PACKAGED SOLUTIONS - HORIZONTAL UNITS - ANCILLARY DETAILS & DIMENSIONS (mm)

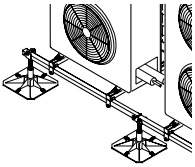
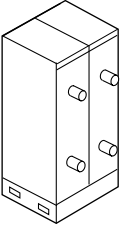
BPS BOXER PACKAGED AHUs - HORIZONTAL ANCILLARY DETAILS & DIMENSIONS (mm)							
BPS Ancillary	Description	Part Number	Width	Height	Length	Weight (kg)	Z Factor
MODULAR SUPPORT FRAME 	BPS size **, Modular support frame	Contact Nuairé for details					
VALVE MODULE 	BPS size **, Valve Module in protective enclosure with LPHW. With Connect or Adapt Trend Control. Includes PICV & Actuator.	B05A/VM-L	450	1050	450	33	
		B10A/VM-L	450	1050	450	36.3	
		B15A/VM-L	450	1050	450	37	
		B20A/VM-L	450	1050	450	46.5	
	BPS size **, Valve Module in protective enclosure with LPHW & Chilled Water. With Connect or Adapt Trend Control. Includes PICV & Actuator.	B05A/VM-LC	450	1050	450	41	
		B10A/VM-LC	450	1050	450	44.3	
		B15A/VM-LC	450	1050	450	48.3	
		B20A/VM-LC	450	1050	450	61.5	
	BPS size **, Valve Module in protective enclosure with Chilled Water. With Connect or Adapt Trend Control. Includes PICV & Actuator.	B05A/VM-C	450	1050	450	33	
		B10A/VM-C	450	1050	450	33	
		B15A/VM-C	450	1050	450	36.3	
		B20A/VM-C	450	1050	450	40	
	Note: For 3 port valves, contact Nuairé. BPS size **, Valve Module in protective enclosure with LPHW. With Classic Control. Includes PICV & Actuator.	B05A/VM-L-ES	450	1050	450	33	
		B10A/VM-L-ES	450	1050	450	36.3	
		B15A/VM-L-ES	450	1050	450	37	
		B20A/VM-L-ES	450	1050	450	46.5	

** Insert either 05, 10, 15 or 20 for the relevant horizontal BPS unit.

BPS BOXER PACKAGED SOLUTIONS - VERTICAL UNITS



DUTY FOR VERTICAL UNITS

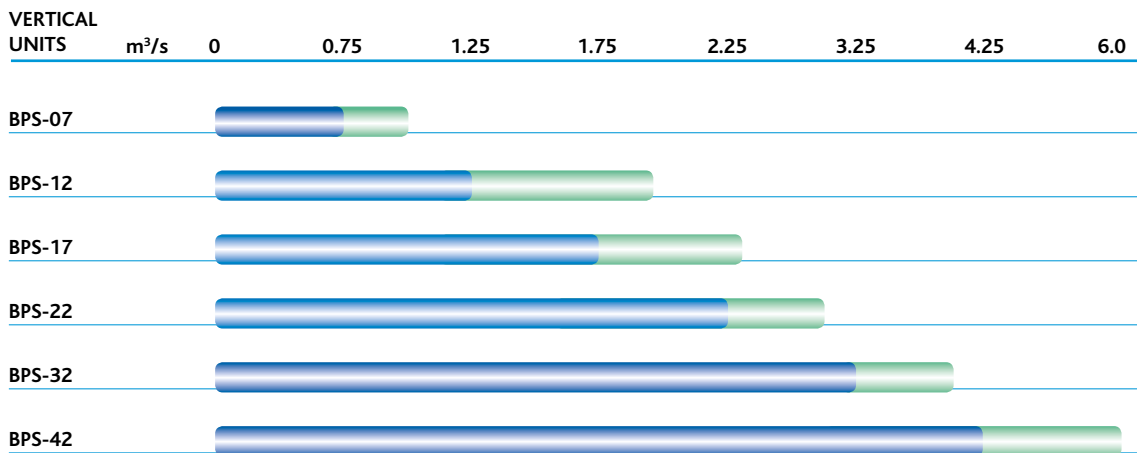

VERTICAL PLATE HEAT EXCHANGER & THERMAL WHEEL UNITS SECTION CONTENTS

BPS VERTICAL UNITS TECHNICAL DATA	38
BPS Unit 07	38
BPS Unit 12	42
BPS Unit 17	46
BPS Unit 22	50
BPS Unit 32	54
BPS Unit 42	58
BPS VERTICAL UNITS HANDINGS & AIRFLOW	62
BPS VERTICAL UNITS ANCILLARIES	64
BPS VERTICAL UNITS WITH MITSUBISHI CONDENSING UNIT	72
BPS CONSULTANT SPECIFICATION	74
BPS VERTICAL UNITS WITH ECOSMART CONTROL	76



BPS BOXER PACKAGED SOLUTIONS - VERTICAL UNIT 07 - PERFORMANCE & TECHNICAL INFORMATION

BPS PERFORMANCE FOR PLATE HEAT EXCHANGER & THERMAL WHEEL UNITS

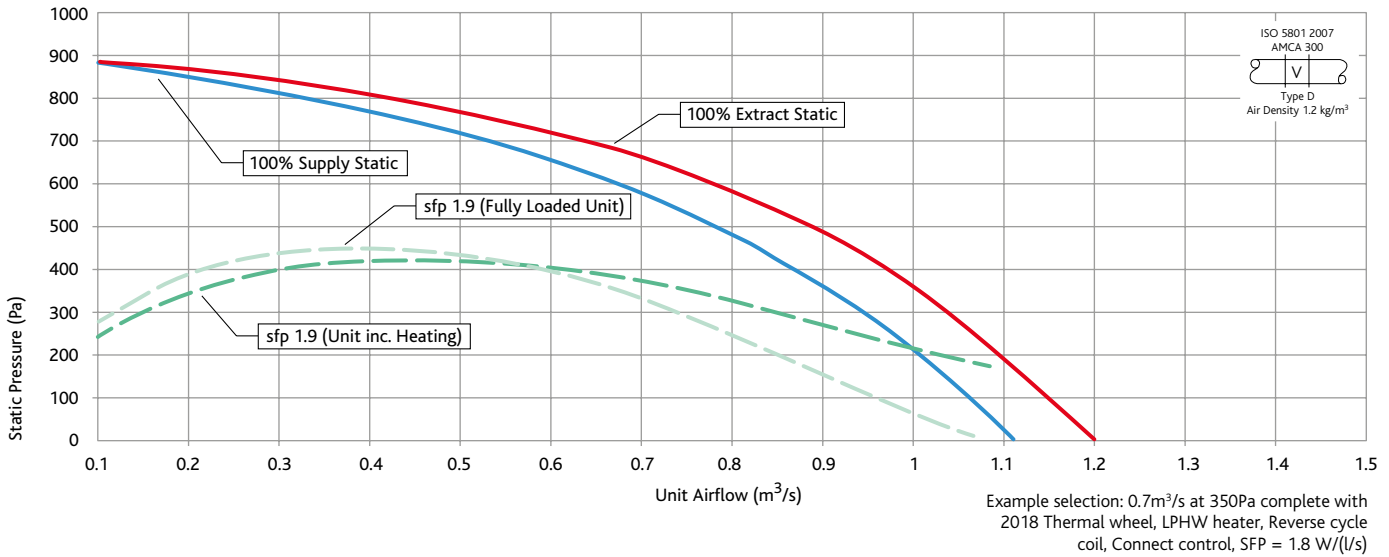

BPS TECHNICAL INFORMATION

Unit Code	Voltage / Phase / Frequency	FLC (A)	Max Operating Temperature	Fan Speed (rpm)	Unit Weight (kg)	PACKAGED WEIGHT (kg)			
						Intake Exhaust Module	PHX or Thermal Wheel Module	Supply Exhaust Module	Electric Heater Module
B807V/LR/**-#	400 / 3 / 50	8.8	40°C	2580	882	223	390	365	-
B807V/LC/**-#	400 / 3 / 50	4.3	40°C	2580	882	223	390	365	-
B807V/LN/**-#	400 / 3 / 50	4.3	40°C	2580	861	223	390	344	-
B807V/ER/**-#	400 / 3 / 50	8.8+17.5*	40°C	2580	998	223	390	348	157
B807V/EC/**-#	400 / 3 / 50	4.3+17.5*	40°C	2580	998	223	390	348	157
B807V/EN/**-#	400 / 3 / 50	4.3+17.5*	40°C	2580	977	223	390	327	157
B807V/NR/**-#	400 / 3 / 50	8.8	40°C	2580	865	223	390	348	-
B807V/NC/**-#	400 / 3 / 50	4.3	40°C	2580	865	223	390	348	-
B807V/NN/**-#	400 / 3 / 50	4.3	40°C	2580	844	223	390	327	-
B807T/LR/**-#	400 / 3 / 50	8.8	40°C	2580	794	223	299	365	-
B807T/LC/**-#	400 / 3 / 50	8.3	40°C	2580	794	223	299	365	-
B807T/LN/**-#	400 / 3 / 50	8.3	40°C	2580	773	223	299	344	-
B807T/ER/**-#	400 / 3 / 50	8.8+17.5*	40°C	2580	910	223	299	348	157
B807T/EC/**-#	400 / 3 / 50	8.3+17.5*	40°C	2580	910	223	299	348	157
B807T/EN/**-#	400 / 3 / 50	8.3+17.5*	40°C	2580	889	223	299	327	157
B807T/NR/**-#	400 / 3 / 50	8.8	40°C	2580	777	223	299	348	-
B807T/NC/**-#	400 / 3 / 50	8.3	40°C	2580	777	223	299	348	-
B807T/NN/**-#	400 / 3 / 50	8.3	40°C	2580	756	223	299	327	-

8** Add relevant control option. i.e AT, CO, ES. # Add relevant handing. i.e L (Left) R (Right).

*FLC: Includes separate supply for a 12kW Heater element.

Please note: All weights displayed are estimated weights and are subject to change. Dimensions are case width and do not include for handles/terminals and switches.

Unit Code	PALLET CRATE DIMENSIONS (mm)			
	Intake / Exhaust Module	PHX or Thermal Wheel Module	Supply / Exhaust Module	Electric / Heater Module
B807V/LR/**-#	950L x 1580W x 1642H	1690L x 1580W x 1642H	1350L x 1580W x 1642H	-
B807V/LC/**-#	950L x 1580W x 1642H	1690L x 1580W x 1642H	1350L x 1580W x 1642H	-
B807V/LN/**-#	950L x 1580W x 1642H	1690L x 1580W x 1642H	1350L x 1580W x 1642H	-
B807V/ER/**-#	950L x 1580W x 1642H	1690L x 1580W x 1642H	1350L x 1580W x 1642H	600L x 1580W x 1642H
B807V/EC/**-#	950L x 1580W x 1642H	1690L x 1580W x 1642H	1350L x 1580W x 1642H	600L x 1580W x 1642H
B807V/EN/**-#	950L x 1580W x 1642H	1690L x 1580W x 1642H	1350L x 1580W x 1642H	600L x 1580W x 1642H
B807V/NR/**-#	950L x 1580W x 1642H	1690L x 1580W x 1642H	1350L x 1580W x 1642H	-
B807V/NC/**-#	950L x 1580W x 1642H	1690L x 1580W x 1642H	1350L x 1580W x 1642H	-
B807V/NN/**-#	950L x 1580W x 1642H	1690L x 1580W x 1642H	1350L x 1580W x 1642H	-
B807T/LR/**-#	950L x 1580W x 1642H	850L x 1580W x 1642H	1350L x 1580W x 1642H	-
B807T/LC/**-#	950L x 1580W x 1642H	850L x 1580W x 1642H	1350L x 1580W x 1642H	-
B807T/LN/**-#	950L x 1580W x 1642H	850L x 1580W x 1642H	1350L x 1580W x 1642H	-
B807T/ER/**-#	950L x 1580W x 1642H	850L x 1580W x 1642H	1350L x 1580W x 1642H	600L x 1580W x 1642H
B807T/EC/**-#	950L x 1580W x 1642H	850L x 1580W x 1642H	1350L x 1580W x 1642H	600L x 1580W x 1642H
B807T/EN/**-#	950L x 1580W x 1642H	850L x 1580W x 1642H	1350L x 1580W x 1642H	600L x 1580W x 1642H
B807T/NR/**-#	950L x 1580W x 1642H	850L x 1580W x 1642H	1350L x 1580W x 1642H	-
B807T/NC/**-#	950L x 1580W x 1642H	850L x 1580W x 1642H	1350L x 1580W x 1642H	-
B807T/NN/**-#	950L x 1580W x 1642H	850L x 1580W x 1642H	1350L x 1580W x 1642H	-

** Add relevant control option. i.e AT, CO, ES. # Add relevant handing. i.e L (Left) R (Right).

Please note: All weights displayed are estimated weights and are subject to change. Dimensions are case width and do not include for handles/terminals and switches.

BPS BOXER PACKAGED SOLUTIONS - VERTICAL UNIT 07 - PERFORMANCE & TECHNICAL INFORMATION

BPS B807V (ErP 2018) NOISE DATA FOR PLATE HEAT EXCHANGER UNITS

Plate Heat Exchanger										
Fan Code	Type	63	125	250	500	1000	2000	4000	8000	(dBA@3m)
B807V	Open Discharge	68	66	73	75	80	79	76	73	41
B807V	Open Intake	62	58	63	60	56	55	52	49	
B807V	Open Supply	68	66	73	75	80	79	76	73	
B807V	Open Extract	62	58	63	60	56	55	52	49	
B807V	Breakout	68	57	63	56	53	45	39	28	
B807V	Breakout	68	57	63	56	53	45	39	28	

BPS B807T (ErP 2018) NOISE DATA FOR THERMAL WHEEL UNITS

Thermal Wheel										
Fan Code	Type	63	125	250	500	1000	2000	4000	8000	(dBA@3m)
B807T	Open Discharge	68	66	73	75	80	79	76	73	41
B807T	Open Intake	65	64	73	72	70	72	70	68	
B807T	Open Supply	68	66	73	75	80	79	76	73	
B807T	Open Extract	65	64	73	72	70	72	70	68	
B807T	Breakout	68	57	63	56	53	45	39	28	
B807T	Breakout	68	57	63	56	53	45	39	28	

THERMAL WHEEL & PLATE HEAT EXCHANGER UNITS - EFFICIENCY

B07 THERMAL WHEEL & HEAT EXCHANGER EFFICIENCY

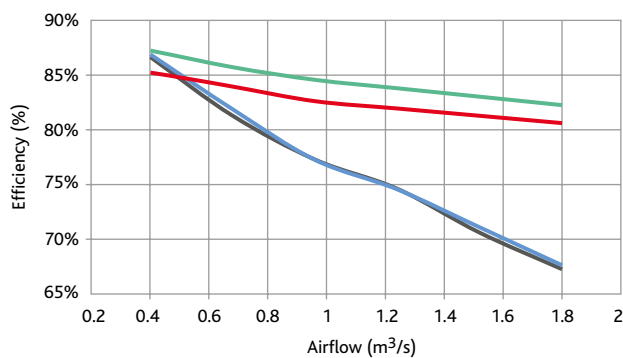

B07 THERMAL WHEEL & HEAT EXCHANGER HEAT RECOVERY

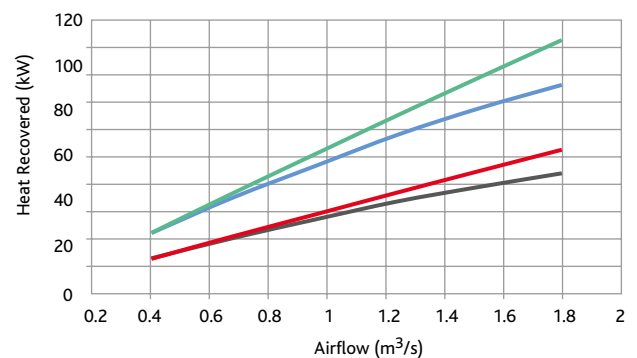

B07 THERMAL WHEEL & HEAT EXCHANGER AIR-OFF TEMPERATURES

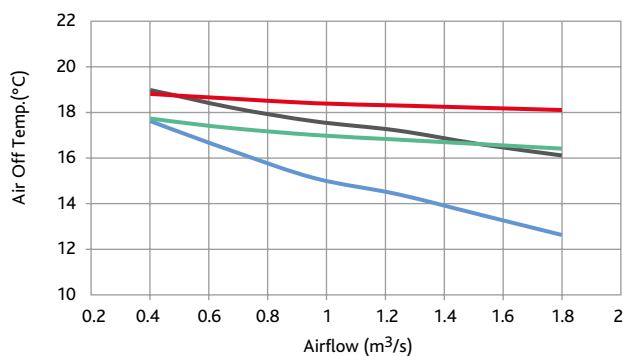

KEY:

- B807T @ 6°C Inlet
- B807T @ -5°C Inlet
- B807V @ 6°C Inlet
- B807V @ -5°C Inlet

All performance data based on indoor condition: 21°C @ 50% RH

BPS BOXER PACKAGED SOLUTIONS - VERTICAL UNIT 07 - COIL DATA

COIL DATA @ 100% SPEED

UNIT CONFIGURATION		AIR INLET CONDITION		AIR CONDITION AFTER HX		WATER PARAMETERS		AIR CONDITION AFTER COIL	
Model Code	Airflow (m³/s)	Dry bulb (°C)	Relative Humidity (%)	Dry bulb (°C)	Relative Humidity (%)	Inlet temp. (°C)	Outlet temp. (°C)	Dry bulb (°C)	Relative Humidity (%)
B807V/*R	0.9	28.0	42.9	22.7	58.8	-	-	13.7	87.8
B807V/*R	0.9	10.0	70.0	18.7	39.9	-	-	33.5	17.5
B807V/*C	0.9	28.0	42.9	22.7	58.8	6.0	12.0	14.8	89.1
B807V/*C	0.9	28.0	42.9	22.7	58.8	8.0	14.0	15.6	91.6
B807V/*C	0.9	28.0	42.9	22.7	58.8	10.0	16.0	17.0	83.7
B807V/L*	0.9	10.0	70.0	18.7	39.9	82.0	71.0	47.4	7.9
B807V/L*	0.9	10.0	70.0	18.7	39.9	80.0	60.0	41.1	11.0
B807V/L*	0.9	10.0	70.0	18.7	39.9	60.0	40.0	29.3	21.1
B807T/*R	1.0	28.0	42.9	22.6	59.2	-	-	14.3	87.0
B807T/*R	1.0	10.0	70.0	18.5	40.3	-	-	31.8	18.5
B807T/*C	1.0	28.0	42.9	22.6	59.2	6.0	12.0	15.0	88.6
B807T/*C	1.0	28.0	42.9	22.6	59.2	8.0	14.0	15.8	90.3
B807T/*C	1.0	28.0	42.9	22.6	59.2	10.0	16.0	17.2	82.7
B807T/L*	1.0	10.0	70.0	18.5	40.3	82.0	71.0	46.1	8.4
B807T/L*	1.0	10.0	70.0	18.5	40.3	80.0	60.0	40.0	11.6
B807T/L*	1.0	10.0	70.0	18.5	40.3	60.0	40.0	28.7	21.8

COIL DATA @ 75% SPEED

B807V/*R	0.7	28.0	42.9	22.6	59.2	-	-	11.8	90.2
B807V/*R	0.7	10.0	70.0	18.8	39.6	-	-	38.6	13.0
B807V/*C	0.7	28.0	42.9	22.6	59.2	6.0	12.0	14.1	90.9
B807V/*C	0.7	28.0	42.9	22.6	59.2	8.0	14.0	15.5	91.0
B807V/*C	0.7	28.0	42.9	22.6	59.2	10.0	16.0	16.5	86.6
B807V/L*	0.7	10.0	70.0	18.8	39.6	82.0	71.0	50.3	6.9
B807V/L*	0.7	10.0	70.0	18.8	39.6	80.0	60.0	43.6	9.6
B807V/L*	0.7	10.0	70.0	18.8	39.6	60.0	40.0	30.6	19.5
B807T/*R	0.8	28.0	42.9	22.4	59.9	-	-	12.7	89.2
B807T/*R	0.8	10.0	70.0	18.8	39.5	-	-	36.6	14.0
B807T/*C	0.8	28.0	42.9	22.4	59.9	6.0	12.0	14.4	90.2
B807T/*C	0.8	28.0	42.9	22.4	59.9	8.0	14.0	15.7	90.3
B807T/*C	0.8	28.0	42.9	22.4	59.9	10.0	16.0	16.7	85.3
B807T/L*	0.8	10.0	70.0	18.8	39.5	82.0	71.0	48.8	7.4
B807T/L*	0.8	10.0	70.0	18.8	39.5	80.0	60.0	42.3	10.3
B807T/L*	0.8	10.0	70.0	18.8	39.5	60.0	40.0	29.9	20.3

COIL DATA @ 50% SPEED

B807V/*R	0.5	28.0	42.9	22.5	59.4	-	-	8.8	93.2
B807V/*R	0.5	10.0	70.0	18.9	39.3	-	-	48.5	7.0
B807V/*C	0.5	28.0	42.9	22.5	59.4	6.0	12.0	13.3	93.0
B807V/*C	0.5	28.0	42.9	22.5	59.4	8.0	14.0	14.9	92.9
B807V/*C	0.5	28.0	42.9	22.5	59.4	10.0	16.0	15.8	90.3
B807V/L*	0.5	10.0	70.0	18.9	39.3	82.0	71.0	54.3	5.6
B807V/L*	0.5	10.0	70.0	18.9	39.3	80.0	60.0	47.1	8.0
B807V/L*	0.5	10.0	70.0	18.9	39.3	60.0	40.0	32.5	17.5
B807T/*R	0.5	28.0	42.9	22.0	61.2	-	-	8.7	93.6
B807T/*R	0.5	10.0	70.0	19.4	38.2	-	-	46.1	8.5
B807T/*C	0.5	28.0	42.9	22.0	61.2	6.0	12.0	13.2	93.4
B807T/*C	0.5	28.0	42.9	22.0	61.2	8.0	14.0	14.8	93.3
B807T/*C	0.5	28.0	42.9	22.0	61.2	10.0	16.0	15.7	90.6
B807T/L*	0.5	10.0	70.0	19.4	38.2	82.0	71.0	54.5	5.6
B807T/L*	0.5	10.0	70.0	19.4	38.2	80.0	60.0	47.3	8.0
B807T/L*	0.5	10.0	70.0	19.4	38.2	60.0	40.0	32.7	17.4

Note: performance is based on an indoor (or space, room etc.) condition of 21°C @ 50%RH.

	HX PERFORMANCE		DX COOLING		DX HEATING	CW COOLING		LPHW HEATING	UNIT PERFORMANCE			
	Free cooling (kW)	Heat recovery (kW)	Sensible (kW)	Gross (kW)	Capacity (kW)	Sensible (kW)	Gross (kW)	Capacity (kW)	Cooling (kW)	Heating (kW)	Water flow (l/s)	Coil Δp (kPa)
	5.7	-	9.7	14.0	-	-	-	-	15.4	-	-	-
	-	9.4	-	-	16.0	-	-	-	-	25.4	-	-
	5.7	-	-	-	-	8.6	10.7	-	14.3	-	0.4	3.0
	5.7	-	-	-	-	7.7	7.7	-	13.4	-	0.3	1.6
	5.7	-	-	-	-	6.1	6.2	-	11.9	-	0.2	1.1
	-	9.4	-	-	-	-	-	31.0	-	40.4	0.7	1.3
	-	9.4	-	-	-	-	-	24.2	-	33.6	0.3	0.3
	-	9.4	-	-	-	-	-	11.4	-	20.8	0.1	0.1
	6.5	-	10.0	14.0	-	-	-	-	16.4	-	-	-
	-	10.2	-	-	16.0	-	-	-	-	26.2	-	-
	6.5	-	-	-	-	9.1	11.2	-	15.6	-	0.4	3.3
	6.5	-	-	-	-	8.1	8.2	-	14.6	-	0.3	1.8
	6.5	-	-	-	-	6.5	6.5	-	13.0	-	0.3	1.2
	-	10.2	-	-	-	-	-	33.1	-	43.3	0.7	1.5
	-	10.2	-	-	-	-	-	25.9	-	36.1	0.3	0.3
	-	10.2	-	-	-	-	-	12.2	-	22.4	0.1	0.1

	4.4	-	8.7	14.0	-	-	-	-	13.1	-	-	-
	-	7.1	-	-	16.0	-	-	-	-	23.1	-	-
	4.4	-	-	-	-	6.9	9.2	-	11.3	-	0.4	2.3
	4.4	-	-	-	-	5.7	6.2	-	10.1	-	0.2	1.1
	4.4	-	-	-	-	5.0	5.2	-	9.3	-	0.2	0.8
	-	7.1	-	-	-	-	-	25.5	-	32.7	0.6	1.0
	-	7.1	-	-	-	-	-	20.1	-	27.2	0.2	0.2
	-	7.1	-	-	-	-	-	9.6	-	16.7	0.1	0.1
	5.0	-	8.7	14.0	-	-	-	-	13.8	-	-	-
	-	7.9	-	-	16.0	-	-	-	-	23.9	-	-
	5.0	-	-	-	-	7.2	9.8	-	12.2	-	0.4	2.6
	5.0	-	-	-	-	6.0	6.5	-	11.0	-	0.3	1.2
	5.0	-	-	-	-	5.1	5.5	-	10.2	-	0.2	0.9
	-	7.9	-	-	-	-	-	27.0	-	34.9	0.6	1.1
	-	7.9	-	-	-	-	-	21.2	-	29.1	0.3	0.2
	-	7.9	-	-	-	-	-	10.0	-	17.9	0.1	0.1

	3.0	-	7.4	14.0	-	-	-	-	10.4	-	-	-
	-	4.8	-	-	16.0	-	-	-	-	20.8	-	-
	3.0	-	-	-	-	5.0	7.4	-	8.0	-	0.3	1.6
	3.0	-	-	-	-	4.1	5.0	-	7.1	-	0.2	0.8
	3.0	-	-	-	-	3.6	4.0	-	6.6	-	0.2	0.5
	-	4.8	-	-	-	-	-	19.1	-	23.9	0.4	0.6
	-	4.8	-	-	-	-	-	15.2	-	20.0	0.2	0.1
	-	4.8	-	-	-	-	-	7.4	-	12.2	0.1	0.04
	3.6	-	8.0	14.0	-	-	-	-	11.6	-	-	-
	-	5.6	-	-	16.0	-	-	-	-	21.6	-	-
	3.6	-	-	-	-	5.3	7.2	-	8.9	-	0.3	1.5
	3.6	-	-	-	-	4.3	4.8	-	7.9	-	0.2	0.7
	3.6	-	-	-	-	3.8	3.8	-	7.4	-	0.2	0.4
	-	5.6	-	-	-	-	-	21.0	-	26.7	0.5	0.6
	-	5.6	-	-	-	-	-	16.7	-	22.4	0.2	0.1
	-	5.6	-	-	-	-	-	8.0	-	13.6	0.1	0.04

BPS BOXER PACKAGED SOLUTIONS - VERTICAL UNIT 12 - PERFORMANCE & TECHNICAL INFORMATION

BPS PERFORMANCE FOR PLATE HEAT EXCHANGER & THERMAL WHEEL UNITS

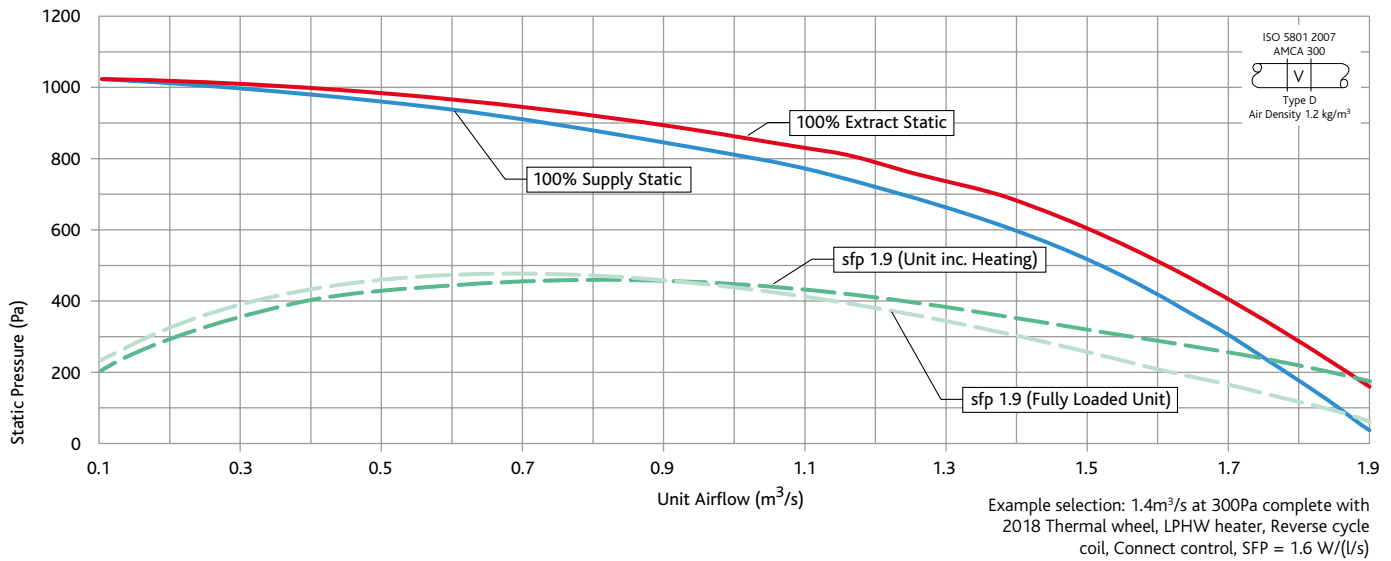

BPS TECHNICAL INFORMATION

Unit Code	Voltage / Phase / Frequency	FLC (A)	Max Operating Temperature	Fan Speed (rpm)	Unit Weight (kg)	PACKAGED WEIGHT (kg)			
						Intake Exhaust Module	PHX or Thermal Wheel Module	Supply Exhaust Module	Electric Heater Module
B812V/LR/**-#	400 / 3 / 50	11.3	40°C	2180	1130	258	535	433	-
B812V/LC/**-#	400 / 3 / 50	6.8	40°C	2180	1130	258	535	433	-
B812V/LN/**-#	400 / 3 / 50	6.8	40°C	2180	1100	258	535	403	-
B812V/ER/**-#	400 / 3 / 50	11.3 + 35*	40°C	2180	1258	258	535	408	169
B812V/EC/**-#	400 / 3 / 50	6.8 + 35*	40°C	2180	1258	258	535	408	169
B812V/EN/**-#	400 / 3 / 50	6.8 + 35*	40°C	2180	1228	258	535	378	169
B812V/NR/**-#	400 / 3 / 50	11.3	40°C	2180	1105	258	535	408	-
B812V/NC/**-#	400 / 3 / 50	6.8	40°C	2180	1105	258	535	408	-
B812V/NN/**-#	400 / 3 / 50	6.8	40°C	2180	1075	258	535	378	-
B812T/LR/**-#	400 / 3 / 50	11.3	40°C	2180	945	258	330	433	-
B812T/LC/**-#	400 / 3 / 50	10.8	40°C	2180	945	258	330	433	-
B812T/LN/**-#	400 / 3 / 50	10.8	40°C	2180	915	258	330	403	-
B812T/ER/**-#	400 / 3 / 50	11.3 + 35*	40°C	2180	1073	258	330	408	169
B812T/EC/**-#	400 / 3 / 50	10.8 + 35*	40°C	2180	1073	258	330	408	169
B812T/EN/**-#	400 / 3 / 50	10.8 + 35*	40°C	2180	1043	258	330	378	169
B812T/NR/**-#	400 / 3 / 50	11.3	40°C	2180	920	258	330	408	-
B812T/NC/**-#	400 / 3 / 50	10.8	40°C	2180	920	258	330	408	-
B812T/NN/**-#	400 / 3 / 50	10.8	40°C	2180	890	258	330	378	-

** Add relevant control option. i.e AT, CO, ES. # Add relevant handing. i.e L (Left) R (Right).

*FLC: Includes separate supply for a 24kW Heater element.

Please note: All weights displayed are estimated weights and are subject to change. Dimensions are case width and do not include for handles/terminals and switches.

Unit Code	PALLET CRATE DIMENSIONS (mm)			
	Intake / Exhaust Module	PHX or Thermal Wheel Module	Supply / Exhaust Module	Electric / Heater Module
B812V/LR/**-#	950L x 2000W x 1817H	1690L x 2000W x 1817H	1350L x 2000W x 1817H	-
B812V/LC/**-#	950L x 2000W x 1817H	1690L x 2000W x 1817H	1350L x 2000W x 1817H	-
B812V/LN/**-#	950L x 2000W x 1817H	1690L x 2000W x 1817H	1350L x 2000W x 1817H	-
B812V/ER/**-#	950L x 2000W x 1817H	1690L x 2000W x 1817H	1350L x 2000W x 1817H	600L x 2000W x 1817H
B812V/EC/**-#	950L x 2000W x 1817H	1690L x 2000W x 1817H	1350L x 2000W x 1817H	600L x 2000W x 1817H
B812V/EN/**-#	950L x 2000W x 1817H	1690L x 2000W x 1817H	1350L x 2000W x 1817H	600L x 2000W x 1817H
B812V/NR/**-#	950L x 2000W x 1817H	1690L x 2000W x 1817H	1350L x 2000W x 1817H	-
B812V/NC/**-#	950L x 2000W x 1817H	1690L x 2000W x 1817H	1350L x 2000W x 1817H	-
B812V/NN/**-#	950L x 2000W x 1817H	1690L x 2000W x 1817H	1350L x 2000W x 1817H	-
B812T/LR/**-#	950L x 2000W x 1817H	850L x 2000W x 1817H	1350L x 2000W x 1817H	-
B812T/LC/**-#	950L x 2000W x 1817H	850L x 2000W x 1817H	1350L x 2000W x 1817H	-
B812T/LN/**-#	950L x 2000W x 1817H	850L x 2000W x 1817H	1350L x 2000W x 1817H	-
B812T/ER/**-#	950L x 2000W x 1817H	850L x 2000W x 1817H	1350L x 2000W x 1817H	600L x 2000W x 1817H
B812T/EC/**-#	950L x 2000W x 1817H	850L x 2000W x 1817H	1350L x 2000W x 1817H	600L x 2000W x 1817H
B812T/EN/**-#	950L x 2000W x 1817H	850L x 2000W x 1817H	1350L x 2000W x 1817H	600L x 2000W x 1817H
B812T/NR/**-#	950L x 2000W x 1817H	850L x 2000W x 1817H	1350L x 2000W x 1817H	-
B812T/NC/**-#	950L x 2000W x 1817H	850L x 2000W x 1817H	1350L x 2000W x 1817H	-
B812T/NN/**-#	950L x 2000W x 1817H	850L x 2000W x 1817H	1350L x 2000W x 1817H	-

** Add relevant control option. i.e AT, CO, ES. # Add relevant handing. i.e L (Left) R (Right).

Please note: All weights displayed are estimated weights and are subject to change. Dimensions are case width and do not include for handles/terminals and switches.

BPS BOXER PACKAGED SOLUTIONS - VERTICAL UNIT 12 - PERFORMANCE & TECHNICAL INFORMATION

BPS B812V (ErP 2018) NOISE DATA FOR PLATE HEAT EXCHANGER UNITS

Plate Heat Exchanger										
Fan Code	Type	63	125	250	500	1000	2000	4000	8000	(dBA@3m)
B812V	Open Discharge	73	71	81	81	83	81	75	71	47
B812V	Open Intake	66	62	72	65	60	58	52	48	
B812V	Open Supply	73	71	81	81	83	81	75	71	
B812V	Open Extract	66	62	72	65	60	58	52	48	
B812V	Breakout	73	61	72	62	55	47	37	26	

BPS B812T (ErP 2018) NOISE DATA FOR THERMAL WHEEL UNITS

Thermal Wheel										
Fan Code	Type	63	125	250	500	1000	2000	4000	8000	(dBA@3m)
B812T	Open Discharge	73	71	81	81	83	81	75	71	47
B812T	Open Intake	69	69	82	77	74	75	70	67	
B812T	Open Supply	73	71	81	81	83	81	75	71	
B812T	Open Extract	69	69	82	77	74	75	70	67	
B812T	Breakout	73	61	72	62	55	47	37	26	

THERMAL WHEEL & PLATE HEAT EXCHANGER UNITS - EFFICIENCY

B12 THERMAL WHEEL & HEAT EXCHANGER EFFICIENCY

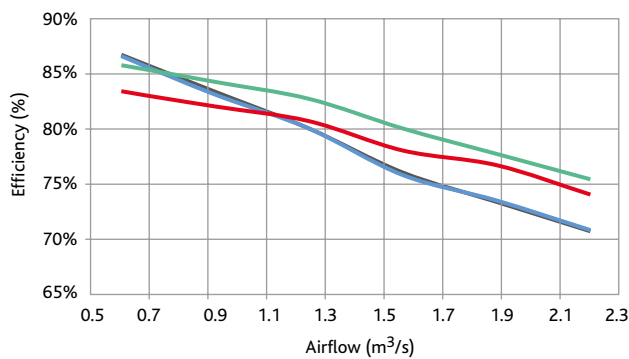

B12 THERMAL WHEEL & HEAT EXCHANGER HEAT RECOVERY

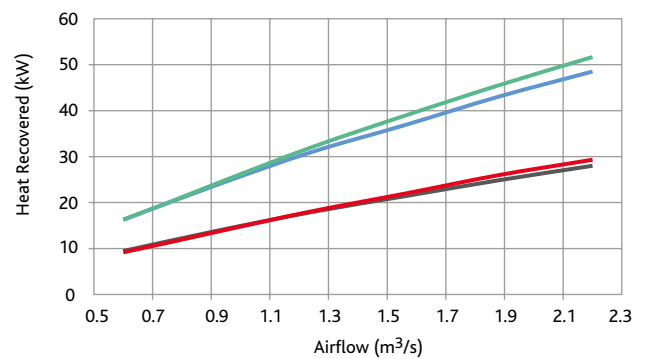

B12 THERMAL WHEEL & HEAT EXCHANGER AIR-OFF TEMPERATURES

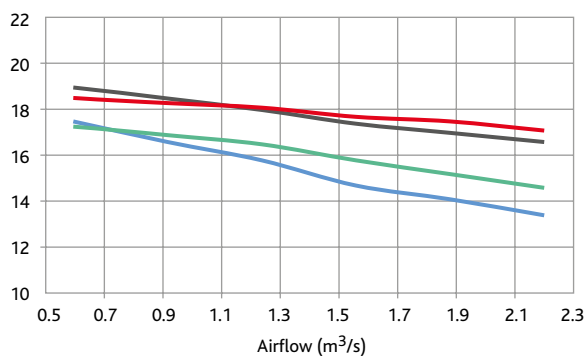

KEY:

- B812T @ 6°C Inlet
- B812T @ -5°C Inlet
- B812V @ 6°C Inlet
- B812V @ -5°C Inlet

All performance data based on indoor condition: 21°C @ 50% RH

BPS BOXER PACKAGED SOLUTIONS - VERTICAL UNIT 12 - COIL DATA

COIL DATA @ 100% SPEED

UNIT CONFIGURATION		AIR INLET CONDITION		AIR CONDITION AFTER HX		WATER PARAMETERS		AIR CONDITION AFTER COIL	
Model Code	Airflow (m³/s)	Dry bulb (°C)	Relative Humidity (%)	Dry bulb (°C)	Relative Humidity (%)	Inlet temp. (°C)	Outlet temp. (°C)	Dry bulb (°C)	Relative Humidity (%)
B812V/*R	1.5	28.0	42.9	22.9	58.0	-	-	14.9	86.1
B812V/*R	1.5	10.0	70.0	18.0	41.5	-	-	30.4	19.0
B812V/*C	1.5	28.0	42.9	22.9	58.0	6.0	12.0	15.1	87.7
B812V/*C	1.5	28.0	42.9	22.9	58.0	8.0	14.0	15.9	89.8
B812V/*C	1.5	28.0	42.9	22.9	58.0	10.0	16.0	17.2	82.4
B812V/L*	1.5	10.0	70.0	18.0	41.5	82.0	71.0	45.0	8.9
B812V/L*	1.5	10.0	70.0	18.0	41.5	80.0	60.0	39.4	12.0
B812V/L*	1.5	10.0	70.0	18.0	41.5	60.0	40.0	28.5	22.0
B812T/*R	1.7	28.0	42.9	22.7	58.6	-	-	15.4	85.3
B812T/*R	1.7	10.0	70.0	18.3	40.9	-	-	29.3	20.0
B812T/*C	1.7	28.0	42.9	22.7	58.6	6.0	12.0	15.3	87.0
B812T/*C	1.7	28.0	42.9	22.7	58.6	8.0	14.0	16.1	88.2
B812T/*C	1.7	28.0	42.9	22.7	58.6	10.0	16.0	17.4	81.2
B812T/L*	1.7	10.0	70.0	18.3	40.9	82.0	71.0	43.8	9.6
B812T/L*	1.7	10.0	70.0	18.3	40.9	80.0	60.0	38.4	12.7
B812T/L*	1.7	10.0	70.0	18.3	40.9	60.0	40.0	28.0	22.7

COIL DATA @ 75% SPEED

B812V/*R	1.1	28.0	42.9	22.7	58.6	-	-	12.9	88.9
B812V/*R	1.1	10.0	70.0	18.3	40.9	-	-	34.9	14.0
B812V/*C	1.1	28.0	42.9	22.7	58.6	6.0	12.0	14.2	90.0
B812V/*C	1.1	28.0	42.9	22.7	58.6	8.0	14.0	15.6	90.0
B812V/*C	1.1	28.0	42.9	22.7	58.6	10.0	16.0	16.5	85.9
B812V/L*	1.1	10.0	70.0	18.3	40.9	82.0	71.0	48.7	7.5
B812V/L*	1.1	10.0	70.0	18.3	40.9	80.0	60.0	42.5	10.2
B812V/L*	1.1	10.0	70.0	18.3	40.9	60.0	40.0	30.3	19.9
B812T/*R	1.3	28.0	42.9	22.5	59.6	-	-	13.9	87.9
B812T/*R	1.3	10.0	70.0	18.7	39.8	-	-	33.3	17.0
B812T/*C	1.3	28.0	42.9	22.5	59.6	6.0	12.0	14.6	89.2
B812T/*C	1.3	28.0	42.9	22.5	59.6	8.0	14.0	15.9	89.2
B812T/*C	1.3	28.0	2.9	22.5	59.6	10.0	16.0	16.8	84.7
B812T/L*	1.3	10.0	70.0	18.7	39.8	82.0	71.0	46.9	8.1
B812T/L*	1.3	10.0	70.0	18.7	39.8	80.0	60.0	41.1	11.0
B812T/L*	1.3	10.0	70.0	18.7	39.8	60.0	40.0	29.6	20.7

COIL DATA @ 50% SPEED

B812V/*R	0.8	28.0	42.9	22.6	59.0	-	-	10.2	91.9
B812V/*R	0.8	10.0	70.0	18.7	39.9	-	-	43.6	8.0
B812V/*C	0.8	28.0	42.9	22.6	59.0	6.0	12.0	13.4	92.1
B812V/*C	0.8	28.0	42.9	22.6	59.0	8.0	14.0	14.9	92.0
B812V/*C	0.8	28.0	42.9	22.6	59.0	10.0	16.0	15.9	89.8
B812V/L*	0.8	10.0	70.0	18.7	39.9	82.0	71.0	52.5	6.1
B812V/L*	0.8	10.0	70.0	18.7	39.9	80.0	60.0	46.0	8.5
B812V/L*	0.8	10.0	70.0	18.7	39.9	60.0	40.0	32.3	17.8
B812T/*R	0.9	28.0	42.9	22.2	60.7	-	-	11.1	91.3
B812T/*R	0.9	10.0	70.0	19.1	38.7	-	-	41.1	10.0
B812T/*C	0.9	28.0	42.9	22.2	60.7	6.0	12.0	13.6	91.9
B812T/*C	0.9	28.0	42.9	22.2	60.7	8.0	14.0	15.1	91.8
B812T/*C	0.9	28.0	42.9	22.2	60.7	10.0	16.0	16.0	89.2
B812T/L*	0.9	10.0	70.0	19.1	38.7	82.0	71.0	51.3	6.5
B812T/L*	0.9	10.0	70.0	19.1	38.7	80.0	60.0	44.9	9.0
B812T/L*	0.9	10.0	70.0	19.1	38.7	60.0	40.0	31.7	18.2

Note: performance is based on an indoor (or space, room etc.) condition of 21°C @ 50%RH.

	HX PERFORMANCE		DX COOLING		DX HEATING	CW COOLING		LPHW HEATING	UNIT PERFORMANCE			
	Free cooling (kW)	Heat recovery (kW)	Sensible (kW)	Gross (kW)	Capacity (kW)	Sensible (kW)	Gross (kW)	Capacity (kW)	Cooling (kW)	Heating (kW)	Water flow (l/s)	Coil Δp (kPa)
	9.2	-	14.4	19.0	-	-	-	-	23.6	-	-	-
	-	14.4	-	-	22.4	-	-	-	-	36.8	-	-
	9.2	-	-	-	-	14.1	17.3	-	23.3	-	0.7	6.4
	9.2	-	-	-	-	12.6	12.7	-	21.8	-	0.5	3.6
	9.2	-	-	-	-	10.2	10.2	-	19.4	-	0.4	2.4
	-	14.4	-	-	-	-	-	48.6	-	63.0	1.1	3.0
	-	14.4	-	-	-	-	-	38.5	-	52.9	0.5	0.6
	-	14.4	-	-	-	-	-	18.9	-	33.3	0.2	0.2
	10.8	-	14.9	19.0	-	-	-	-	25.7	-	-	-
	-	16.9	-	-	22.4	-	-	-	-	39.3	-	-
	10.8	-	-	-	-	15.0	18.2	-	25.8	-	0.7	7.0
	10.8	-	-	-	-	13.4	13.4	-	24.2	-	0.5	4.0
	10.8	-	-	-	-	10.7	10.8	-	21.6	-	0.4	2.6
	-	16.9	-	-	-	-	-	51.9	-	68.9	1.1	3.4
	-	16.9	-	-	-	-	-	41.0	-	57.9	0.5	0.7
	-	16.9	-	-	-	-	-	19.9	-	36.8	0.2	0.2

	7.2	-	13.2	19.0	-	-	-	-	20.4	-	-	-
	-	11.2	-	-	22.4	-	-	-	-	33.6	-	-
	7.2	-	-	-	-	11.4	14.4	-	18.6	-	0.6	4.5
	7.2	-	-	-	-	9.6	9.8	-	16.7	-	0.4	2.2
	7.2	-	-	-	-	8.3	8.2	-	15.5	-	0.3	1.6
	-	11.2	-	-	-	-	-	41.0	-	52.2	0.9	2.1
	-	11.2	-	-	-	-	-	32.7	-	43.9	0.4	0.5
	-	11.2	-	-	-	-	-	16.2	-	27.4	0.2	0.1
	8.4	-	13.2	19.0	-	-	-	-	21.6	-	-	-
	-	13.3	-	-	22.4	-	-	-	-	35.7	-	-
	8.4	-	-	-	-	12.1	15.7	-	20.5	-	0.6	5.3
	8.4	-	-	-	-	10.1	10.6	-	18.5	-	0.4	2.6
	8.4	-	-	-	-	8.7	8.9	-	17.1	-	0.4	1.8
	-	13.3	-	-	-	-	-	43.2	-	56.5	0.9	2.5
	-	13.3	-	-	-	-	-	34.3	-	47.6	0.4	0.5
	-	13.3	-	-	-	-	-	16.7	-	30.0	0.2	0.1

	4.9	-	11.2	19.0	-	-	-	-	16.0	-	-	-
	-	7.8	-	-	22.4	-	-	-	-	30.2	-	-
	4.9	-	-	-	-	8.3	11.9	-	13.1	-	0.5	3.2
	4.9	-	-	-	-	6.9	8.1	-	11.8	-	0.3	1.6
	4.9	-	-	-	-	6.1	6.5	-	10.9	-	0.3	1.0
	-	7.8	-	-	-	-	-	30.5	-	38.3	0.7	1.4
	-	7.8	-	-	-	-	-	24.5	-	32.4	0.3	0.3
	-	7.8	-	-	-	-	-	12.2	-	20.0	0.1	0.1
	5.9	-	11.3	19.0	-	-	-	-	17.2	-	-	-
	-	9.3	-	-	22.4	-	-	-	-	31.7	-	-
	5.9	-	-	-	-	8.8	12.5	-	14.7	-	0.5	3.5
	5.9	-	-	-	-	7.2	8.5	-	13.1	-	0.3	1.7
	5.9	-	-	-	-	6.3	6.7	-	12.2	-	0.3	1.1
	-	9.3	-	-	-	-	-	32.9	-	42.2	0.7	1.6
	-	9.3	-	-	-	-	-	26.3	-	35.6	0.3	0.3
	-	9.3	-	-	-	-	-	12.9	-	22.2	0.2	0.1

BPS BOXER PACKAGED SOLUTIONS - VERTICAL UNIT 17 - PERFORMANCE & TECHNICAL INFORMATION

BPS PERFORMANCE FOR PLATE HEAT EXCHANGER & THERMAL WHEEL UNITS

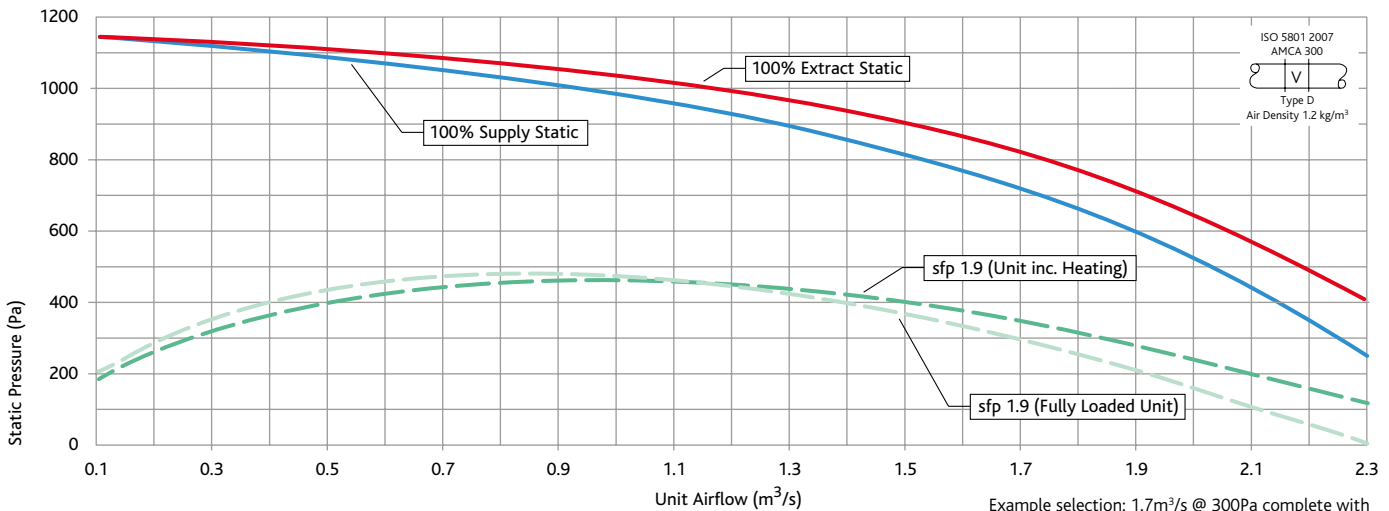

Example selection: 1.7m³/s @ 300Pa complete with LPHW heater, 2018 Thermal Wheel, LPHW frost coil, chilled water, attenuation and Ecosmart Connect control, SFP = 1.6 W(l/s).

BPS TECHNICAL INFORMATION

Unit Code	Voltage / Phase / Frequency	FLC (A)	Max Operating Temperature	Fan Speed (rpm)	Unit Weight (kg)	PACKAGED WEIGHT (kg)			
						Intake Exhaust Module	PHX or Thermal Wheel Module	Supply Exhaust Module	Electric Heater Module
B817V/LR/**-#	400 / 3 / 50	14	40°C	2040	1205	270	560	480	-
B817V/LC/**-#	400 / 3 / 50	9.5	40°C	2040	1240	270	560	515	-
B817V/LN/**-#	400 / 3 / 50	9.5	40°C	2040	1180	270	560	455	-
B817V/ER/**-#	400 / 3 / 50	14 + 53*	40°C	2040	1320	270	560	455	165
B817V/EC/**-#	400 / 3 / 50	9.5 + 53*	40°C	2040	1355	270	560	490	165
B817V/EN/**-#	400 / 3 / 50	9.5 + 53*	40°C	2040	1295	270	560	420	165
B817V/NR/**-#	400 / 3 / 50	14	40°C	2040	1180	270	560	455	-
B817V/NC/**-#	400 / 3 / 50	9.5	40°C	2040	1215	270	560	490	-
B817V/NN/**-#	400 / 3 / 50	9.5	40°C	2040	1155	270	560	430	-
B817T/LR/**-#	400 / 3 / 50	14	40°C	2040	1105	270	445	480	-
B817T/LC/**-#	400 / 3 / 50	14	40°C	2040	1140	270	445	515	-
B817T/LN/**-#	400 / 3 / 50	14	40°C	2040	1080	270	445	455	-
B817T/ER/**-#	400 / 3 / 50	14 + 53*	40°C	2040	1220	270	445	455	165
B817T/EC/**-#	400 / 3 / 50	14 + 53*	40°C	2040	1255	270	445	490	165
B817T/EN/**-#	400 / 3 / 50	14 + 53*	40°C	2040	1195	270	445	430	165
B817T/NR/**-#	400 / 3 / 50	14	40°C	2040	1080	270	445	455	-
B817T/NC/**-#	400 / 3 / 50	14	40°C	2040	1115	270	445	490	-
B817T/NN/**-#	400 / 3 / 50	14	40°C	2040	1055	270	445	430	-

** Add relevant control option. i.e AT, CO, ES. # Add relevant handing. i.e L (Left) R (Right).

*FLC: Includes separate supply for a 36kW Heater element.

Please note: All weights displayed are estimated weights and are subject to change. Dimensions are case width and do not include for handles/terminals and switches.

Unit Code	PALLET CRATE DIMENSIONS (mm)			
	Intake / Exhaust Module	PHX or Thermal Wheel Module	Supply / Exhaust Module	Electric / Heater Module
B817V/LR/**-#	950L x 2000W x 2022H	1690L x 2000W x 2022H	1350L x 2000W x 2022H	-
B817V/LC/**-#	950L x 2000W x 2022H	1690L x 2000W x 2022H	1350L x 2000W x 2022H	-
B817V/LN/**-#	950L x 2000W x 2022H	1690L x 2000W x 2022H	1350L x 2000W x 2022H	-
B817V/ER/**-#	950L x 2000W x 2022H	1690L x 2000W x 2022H	1350L x 2000W x 2022H	600L x 2000W x 2022H
B817V/EC/**-#	950L x 2000W x 2022H	1690L x 2000W x 2022H	1350L x 2000W x 2022H	600L x 2000W x 2022H
B817V/EN/**-#	950L x 2000W x 2022H	1690L x 2000W x 2022H	1350L x 2000W x 2022H	600L x 2000W x 2022H
B817V/NR/**-#	950L x 2000W x 2022H	1690L x 2000W x 2022H	1350L x 2000W x 2022H	-
B817V/NC/**-#	950L x 2000W x 2022H	1690L x 2000W x 2022H	1350L x 2000W x 2022H	-
B817V/NN/**-#	950L x 2000W x 2022H	1690L x 2000W x 2022H	1350L x 2000W x 2022H	-
B817T/LR/**-#	950L x 2000W x 2022H	850L x 2000W x 2022H	1350L x 2000W x 2022H	-
B817T/LC/**-#	950L x 2000W x 2022H	850L x 2000W x 2022H	1350L x 2000W x 2022H	-
B817T/LN/**-#	950L x 2000W x 2022H	850L x 2000W x 2022H	1350L x 2000W x 2022H	-
B817T/ER/**-#	950L x 2000W x 2022H	850L x 2000W x 2022H	1350L x 2000W x 2022H	600L x 2000W x 2022H
B817T/EC/**-#	950L x 2000W x 2022H	850L x 2000W x 2022H	1350L x 2000W x 2022H	600L x 2000W x 2022H
B817T/EN/**-#	950L x 2000W x 2022H	850L x 2000W x 2022H	1350L x 2000W x 2022H	600L x 2000W x 2022H
B817T/NR/**-#	950L x 2000W x 2022H	850L x 2000W x 2022H	1350L x 2000W x 2022H	-
B817T/NC/**-#	950L x 2000W x 2022H	850L x 2000W x 2022H	1350L x 2000W x 2022H	-
B817T/NN/**-#	950L x 2000W x 2022H	850L x 2000W x 2022H	1350L x 2000W x 2022H	-

** Add relevant control option. i.e AT, CO, ES. # Add relevant handing. i.e L (Left) R (Right).

Please note: All weights displayed are estimated weights and are subject to change. Dimensions are case width and do not include for handles/terminals and switches.

BPS BOXER PACKAGED SOLUTIONS - VERTICAL UNIT 17 - PERFORMANCE & TECHNICAL INFORMATION

BPS B817V (ErP 2018) NOISE DATA FOR PLATE HEAT EXCHANGER UNITS

Plate Heat Exchanger		63	125	250	500	1000	2000	4000	8000	(dBA@3m)
Fan Code	Type									
B817V	Open Discharge	73	72	82	86	85	81	77	75	49
B817V	Open Intake	61	53	66	58	56	52	39	29	
B817V	Open Supply	73	72	82	86	85	81	77	75	
B817V	Open Extract	61	53	66	58	56	52	39	29	
B817V	Breakout	72	62	71	66	57	46	40	30	

BPS B817T (ErP 2018) NOISE DATA FOR THERMAL WHEEL UNITS

Thermal Wheel		63	125	250	500	1000	2000	4000	8000	(dBA@3m)
Fan Code	Type									
B817T	Open Discharge	73	72	82	86	85	81	77	75	49
B817T	Open Intake	69	70	81	80	76	74	73	74	
B817T	Open Supply	73	72	82	86	85	81	77	75	
B817T	Open Extract	69	70	81	80	76	74	73	74	
B817T	Breakout	72	62	71	66	57	46	40	30	

THERMAL WHEEL & PLATE HEAT EXCHANGER UNITS - EFFICIENCY

B17 THERMAL WHEEL & HEAT EXCHANGER EFFICIENCY

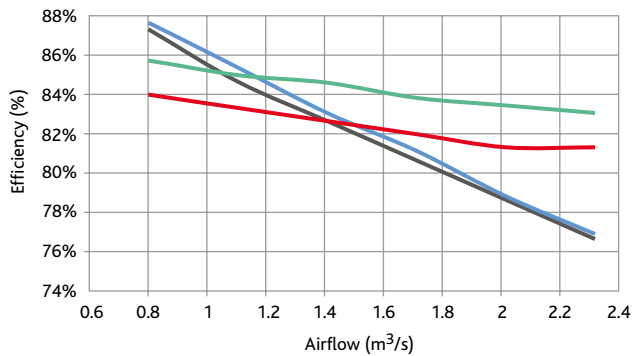

B17 THERMAL WHEEL & HEAT EXCHANGER HEAT RECOVERY

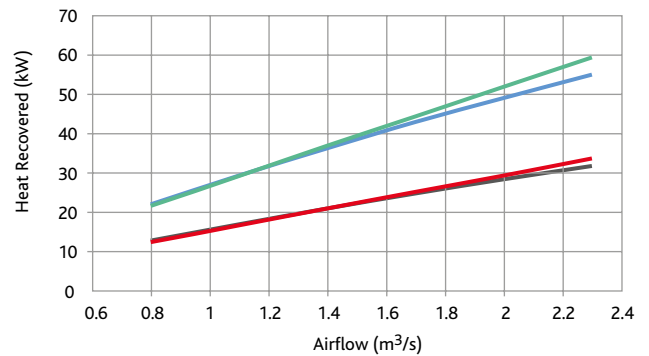

B17 THERMAL WHEEL & HEAT EXCHANGER AIR-OFF TEMPERATURES

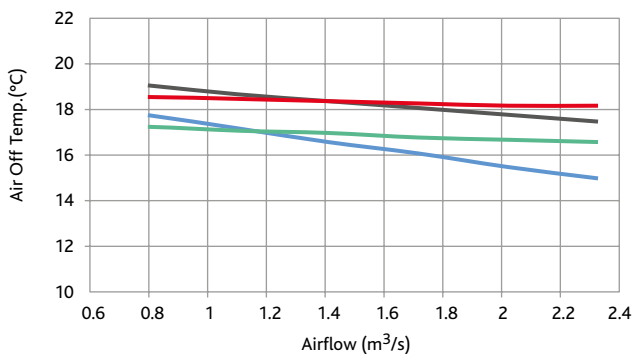

KEY:

- B817T @ 6°C Inlet
- B817T @ -5°C Inlet
- B817V @ 6°C Inlet
- B817V @ -5°C Inlet

All performance data based on indoor condition: 21°C @ 50% RH

BPS BOXER PACKAGED SOLUTIONS - VERTICAL UNIT 17 - COIL DATA

COIL DATA @ 100% SPEED

UNIT CONFIGURATION		AIR INLET CONDITION		AIR CONDITION AFTER HX		WATER PARAMETERS		AIR CONDITION AFTER COIL	
Model Code	Airflow (m³/s)	Dry bulb (°C)	Relative Humidity (%)	Dry bulb (°C)	Relative Humidity (%)	Inlet temp. (°C)	Outlet temp. (°C)	Dry bulb (°C)	Relative Humidity (%)
B817V/*R	1.9	28.0	42.9	22.6	58.9	-	-	13.6	90.4
B817V/*R	1.9	10.0	70.0	18.6	40.0	-	-	32.6	17.5
B817V/*C	1.9	28.0	42.9	22.6	58.9	6.0	12.0	13.7	92.3
B817V/*C	1.9	28.0	42.9	22.6	58.9	8.0	14.0	15.2	92.3
B817V/*C	1.9	28.0	42.9	22.6	58.9	10.0	16.0	16.1	88.4
B817V/L*	1.9	10.0	70.0	18.6	40.0	82.0	71.0	44.5	9.2
B817V/L*	1.9	10.0	70.0	18.6	40.0	80.0	60.0	39.2	12.1
B817V/L*	1.9	10.0	70.0	18.6	40.0	60.0	40.0	28.7	21.7
B817T/*R	2.0	28.0	42.9	22.5	59.5	-	-	13.9	90.2
B817T/*R	2.0	10.0	70.0	18.7	39.8	-	-	32.0	18.0
B817T/*C	2.0	28.0	42.9	22.5	59.5	6.0	12.0	14.7	89.0
B817T/*C	2.0	28.0	42.9	22.5	59.5	8.0	14.0	15.9	89.0
B817T/*C	2.0	28.0	42.9	22.5	59.5	10.0	16.0	16.9	84.4
B817T/L*	2.0	10.0	70.0	18.7	39.8	82.0	71.0	44.0	9.4
B817T/L*	2.0	10.0	70.0	18.7	39.8	80.0	60.0	38.8	12.4
B817T/L*	2.0	10.0	70.0	18.7	39.8	60.0	40.0	28.5	22.0

COIL DATA @ 75% SPEED

B817V/*R	1.4	28.0	42.9	22.6	59.2	-	-	11.6	92.8
B817V/*R	1.4	10.0	70.0	18.7	39.8	-	-	37.4	13.0
B817V/*C	1.4	28.0	42.9	22.6	59.2	6.0	12.0	13.8	91.3
B817V/*C	1.4	28.0	42.9	22.6	59.2	8.0	14.0	15.2	90.3
B817V/*C	1.4	28.0	42.9	22.6	59.2	10.0	16.0	16.2	88.4
B817V/L*	1.4	10.0	70.0	18.7	39.8	82.0	71.0	48.0	7.7
B817V/L*	1.4	10.0	70.0	18.7	39.8	80.0	60.0	42.2	10.4
B817V/L*	1.4	10.0	70.0	18.7	39.8	60.0	40.0	30.3	19.8
B817T/*R	1.5	28.0	42.9	22.2	60.4	-	-	11.8	92.6
B817T/*R	1.5	10.0	70.0	19.1	38.9	-	-	36.9	12.5
B817T/*C	1.5	28.0	42.9	22.2	60.4	6.0	12.0	13.9	91.2
B817T/*C	1.5	28.0	42.9	22.2	60.4	8.0	14.0	15.3	91.2
B817T/*C	1.5	28.0	42.9	22.2	60.4	10.0	16.0	16.2	87.7
B817T/L*	1.5	10.0	70.0	19.1	38.9	82.0	71.0	47.4	8.0
B817T/L*	1.5	10.0	70.0	19.1	38.9	80.0	60.0	41.7	10.6
B817T/L*	1.5	10.0	70.0	19.1	38.9	60.0	40.0	30.2	20.1

COIL DATA @ 50% SPEED

B817V/*R	1.0	28.0	42.9	22.5	59.4	-	-	8.2	95.5
B817V/*R	1.0	10.0	70.0	18.8	38.5	-	-	46.9	7.0
B817V/*C	1.0	28.0	42.9	22.5	59.4	6.0	12.0	12.9	93.3
B817V/*C	1.0	28.0	42.9	22.5	59.4	8.0	14.0	14.5	93.3
B817V/*C	1.0	28.0	42.9	22.5	59.4	10.0	16.0	15.4	92.3
B817V/L*	1.0	10.0	70.0	18.8	38.5	82.0	71.0	51.9	6.2
B817V/L*	1.0	10.0	70.0	18.8	38.5	80.0	60.0	45.6	8.4
B817V/L*	1.0	10.0	70.0	18.8	38.5	60.0	40.0	32.3	17.3
B817T/*R	1.0	28.0	42.9	22.0	61.4	-	-	8.0	95.9
B817T/*R	1.0	10.0	70.0	19.5	38.0	-	-	46.2	8.0
B817T/*C	1.0	28.0	42.9	22.0	61.4	6.0	12.0	12.8	93.8
B817T/*C	1.0	28.0	42.9	22.0	61.4	8.0	14.0	14.5	93.7
B817T/*C	1.0	28.0	42.9	22.0	61.4	10.0	16.0	15.4	92.9
B817T/L*	1.0	10.0	70.0	19.5	38.0	82.0	71.0	52.2	6.3
B817T/L*	1.0	10.0	70.0	19.5	38.0	80.0	60.0	45.9	8.6
B817T/L*	1.0	10.0	70.0	19.5	38.0	60.0	40.0	32.6	17.6

Pipe connection sizes are : LPHW Frost Coil 22mm dia, LPHW coil 35mm dia & Chilled Water 35mm dia.
Note: performance is based on an indoor (or space, room etc.) condition of 21°C @ 50%RH.

	HX PERFORMANCE		DX COOLING		DX HEATING	CW COOLING		LPHW HEATING	UNIT PERFORMANCE			
	Free cooling (kW)	Heat recovery (kW)	Sensible (kW)	Gross (kW)	Capacity (kW)	Sensible (kW)	Gross (kW)	Capacity (kW)	Cooling (kW)	Heating (kW)	Water flow (l/s)	Coil Δp (kPa)
	12.3	-	20.5	28.0	-	-	-	-	32.8	-	-	-
	-	19.6	-	-	32.0	-	-	-	-	51.6	-	-
	12.3	-	-	-	-	20.3	26.1	-	32.6	-	1.0	7.7
	12.3	-	-	-	-	16.9	17.7	-	29.2	-	0.7	3.8
	12.3	-	-	-	-	14.8	14.9	-	27.1	-	0.6	2.7
	-	19.6	-	-	-	-	-	59.1	-	78.7	1.3	4.4
	-	19.6	-	-	-	-	-	47.0	-	66.6	0.6	0.9
	-	19.6	-	-	-	-	-	23.0	-	42.6	0.3	0.3
	13.2	-	20.6	28.0	-	-	-	-	33.8	-	-	-
	-	20.9	-	-	32.0	-	-	-	-	52.9	-	-
	13.2	-	-	-	-	18.7	23.7	-	31.9	-	0.9	6.4
	13.2	-	-	-	-	15.8	16.1	-	29.0	-	0.6	2.1
	13.2	-	-	-	-	13.4	13.5	-	26.6	-	0.5	1.5
	-	20.9	-	-	-	-	-	60.7	-	81.6	1.3	4.6
	-	20.9	-	-	-	-	-	48.2	-	69.1	0.6	1.0
	-	20.9	-	-	-	-	-	23.5	-	44.4	0.3	0.3

	9.2	-	18.8	28.0	-	-	-	-	28.0	-	-	-
	-	14.9	-	-	32.0	-	-	-	-	46.9	-	-
	9.2	-	-	-	-	15.0	19.6	-	24.3	-	0.8	4.5
	9.2	-	-	-	-	12.7	13.5	-	21.9	-	0.5	2.3
	9.2	-	-	-	-	10.9	10.9	-	20.2	-	0.4	1.5
	-	14.9	-	-	-	-	-	50.1	-	65.0	1.1	3.1
	-	14.9	-	-	-	-	-	40.2	-	55.1	0.5	0.7
	-	14.9	-	-	-	-	-	19.8	-	34.7	0.2	0.2
	10.4	-	18.7	28.0	-	-	-	-	29.2	-	-	-
	-	16.4	-	-	32.0	-	-	-	-	48.4	-	-
	10.4	-	-	-	-	14.9	19.7	-	25.4	-	0.8	4.6
	10.4	-	-	-	-	12.4	13.3	-	22.9	-	0.5	2.2
	10.4	-	-	-	-	10.8	10.8	-	21.2	-	0.4	1.0
	-	16.4	-	-	-	-	-	50.9	-	67.3	1.1	3.3
	-	16.4	-	-	-	-	-	40.7	-	57.1	0.5	0.7
	-	16.4	-	-	-	-	-	20.0	-	36.4	0.2	0.2

	6.3	-	16.3	28.0	-	-	-	-	22.6	-	-	-
	-	10.0	-	-	32.0	-	-	-	-	42.0	-	-
	6.3	-	-	-	-	10.9	15.8	-	17.2	-	0.6	3.1
	6.3	-	-	-	-	9.1	11.0	-	15.4	-	0.4	1.6
	6.3	-	-	-	-	8.1	8.5	-	14.4	-	0.3	1.0
	-	10.0	-	-	-	-	-	37.7	-	47.8	0.8	2.1
	-	10.0	-	-	-	-	-	30.6	-	40.6	0.4	0.5
	-	10.0	-	-	-	-	-	15.4	-	25.4	0.2	0.1
	7.2	-	16.8	28.0	-	-	-	-	24.0	-	-	-
	-	11.4	-	-	32.0	-	-	-	-	43.4	-	-
	7.2	-	-	-	-	11.0	15.4	-	18.2	-	0.6	2.9
	7.2	-	-	-	-	9.0	10.6	-	16.2	-	0.4	1.5
	7.2	-	-	-	-	7.9	8.0	-	15.1	-	0.3	0.9
	-	11.4	-	-	-	-	-	39.2	-	50.6	0.9	2.0
	-	11.4	-	-	-	-	-	31.7	-	43.1	0.4	0.4
	-	11.4	-	-	-	-	-	15.7	-	27.1	0.2	0.1

BPS BOXER PACKAGED SOLUTIONS - VERTICAL UNIT 22 - PERFORMANCE & TECHNICAL INFORMATION

BPS PERFORMANCE FOR PLATE HEAT EXCHANGER & THERMAL WHEEL UNITS

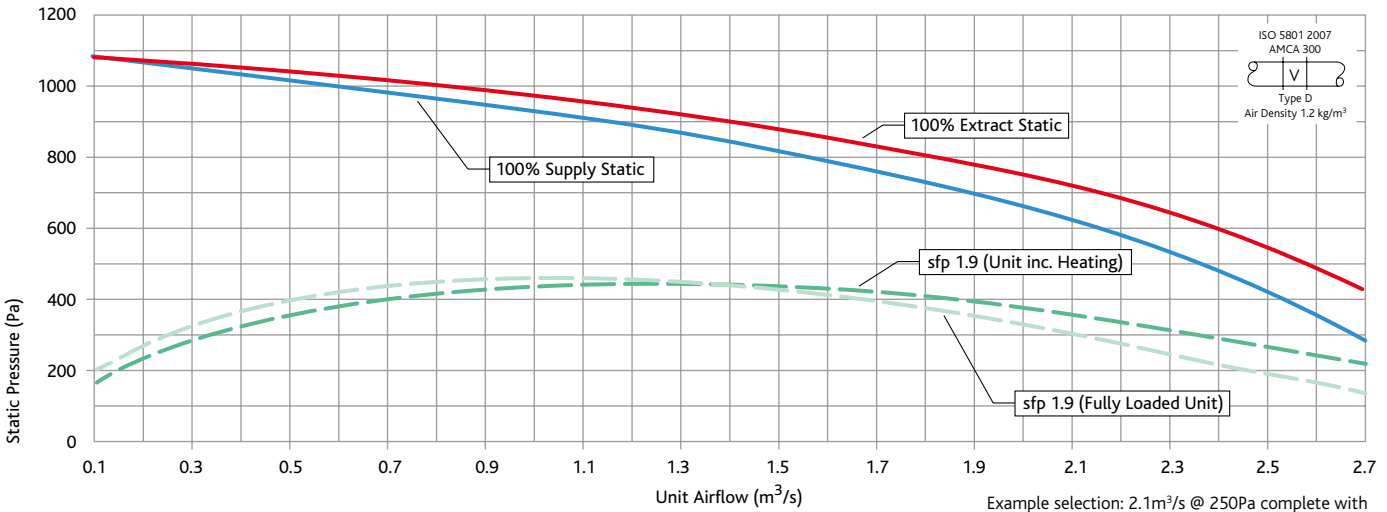

BPS TECHNICAL INFORMATION

Unit Code	Voltage / Phase / Frequency	FLC (A)	Max Operating Temperature	Fan Speed (rpm)	Unit Weight (kg)	PACKAGED WEIGHT (kg)			
						Intake Exhaust Module	PHX or Thermal Wheel Module	Supply Exhaust Module	Electric Heater Module
B822V/LR/**-#	400 / 3 / 50	14.5	40°C	1780	1593	318	788	598	-
B822V/LC/**-#	400 / 3 / 50	10	40°C	1780	1596	318	788	601	-
B822V/LN/**-#	400 / 3 / 50	10	40°C	1780	1528	318	788	533	-
B822V/ER/**-#	400 / 3 / 50	14.5 + 52.5*	40°C	1780	1740	318	788	550	222
B822V/EC/**-#	400 / 3 / 50	10 + 52.5*	40°C	1780	1743	318	788	553	222
B822V/EN/**-#	400 / 3 / 50	10 + 52.5*	40°C	1780	1675	318	788	485	222
B822V/NR/**-#	400 / 3 / 50	14.5	40°C	1780	1545	318	788	550	-
B822V/NC/**-#	400 / 3 / 50	10	40°C	1780	1548	318	788	553	-
B822V/NN/**-#	400 / 3 / 50	10	40°C	1780	1480	318	788	485	-
B822T/LR/**-#	400 / 3 / 50	14.5	40°C	1780	1363	318	533	598	-
B822T/LC/**-#	400 / 3 / 50	14	40°C	1780	1366	318	533	601	-
B822T/LN/**-#	400 / 3 / 50	14	40°C	1780	1298	318	533	533	-
B822T/ER/**-#	400 / 3 / 50	14.5 + 52.5*	40°C	1780	1510	318	533	550	222
B822T/EC/**-#	400 / 3 / 50	14 + 52.5*	40°C	1780	1513	318	533	553	222
B822T/EN/**-#	400 / 3 / 50	14 + 52.5*	40°C	1780	1445	318	533	485	222
B822T/NR/**-#	400 / 3 / 50	14.5	40°C	1780	1315	318	533	550	-
B822T/NC/**-#	400 / 3 / 50	14	40°C	1780	1318	318	533	553	-
B822T/NN/**-#	400 / 3 / 50	14	40°C	1780	1250	318	533	485	-

** Add relevant control option. i.e AT, CO, ES. # Add relevant handing. i.e L (Left) R (Right).

*FLC: Includes separate supply for a 36kW Heater element.

Please note: All weights displayed are estimated weights and are subject to change. Dimensions are case width and do not include for handles/terminals and switches.

Unit Code	PALLET CRATE DIMENSIONS (mm)			
	Intake / Exhaust Module	PHX or Thermal Wheel Module	Supply / Exhaust Module	Electric / Heater Module
B822V/LR/**-#	950L x 2280W x 2320H	2000L x 2280W x 2320H	1450L x 2280W x 2320H	-
B822V/LC/**-#	950L x 2280W x 2320H	2000L x 2280W x 2320H	1450L x 2280W x 2320H	-
B822V/LN/**-#	950L x 2280W x 2320H	2000L x 2280W x 2320H	1450L x 2280W x 2320H	-
B822V/ER/**-#	950L x 2280W x 2320H	2000L x 2280W x 2320H	1450L x 2280W x 2320H	600L x 2280W x 2320H
B822V/EC/**-#	950L x 2280W x 2320H	2000L x 2280W x 2320H	1450L x 2280W x 2320H	600L x 2280W x 2320H
B822V/EN/**-#	950L x 2280W x 2320H	2000L x 2280W x 2320H	1450L x 2280W x 2320H	600L x 2280W x 2320H
B822V/NR/**-#	950L x 2280W x 2320H	2000L x 2280W x 2320H	1450L x 2280W x 2320H	-
B822V/NC/**-#	950L x 2280W x 2320H	2000L x 2280W x 2320H	1450L x 2280W x 2320H	-
B822V/NN/**-#	950L x 2280W x 2320H	2000L x 2280W x 2320H	1450L x 2280W x 2320H	-
B822T/LR/**-#	950L x 2280W x 2320H	850L x 2280W x 2320H	1450L x 2280W x 2320H	-
B822T/LC/**-#	950L x 2280W x 2320H	850L x 2280W x 2320H	1450L x 2280W x 2320H	-
B822T/LN/**-#	950L x 2280W x 2320H	850L x 2280W x 2320H	1450L x 2280W x 2320H	-
B822T/ER/**-#	950L x 2280W x 2320H	850L x 2280W x 2320H	1450L x 2280W x 2320H	600L x 2280W x 2320H
B822T/EC/**-#	950L x 2280W x 2320H	850L x 2280W x 2320H	1450L x 2280W x 2320H	600L x 2280W x 2320H
B822T/EN/**-#	950L x 2280W x 2320H	850L x 2280W x 2320H	1450L x 2280W x 2320H	600L x 2280W x 2320H
B822T/NR/**-#	950L x 2280W x 2320H	850L x 2280W x 2320H	1450L x 2280W x 2320H	-
B822T/NC/**-#	950L x 2280W x 2320H	850L x 2280W x 2320H	1450L x 2280W x 2320H	-
B822T/NN/**-#	950L x 2280W x 2320H	850L x 2280W x 2320H	1450L x 2280W x 2320H	-

** Add relevant control option. i.e AT, CO, ES. # Add relevant handing. i.e L (Left) R (Right).

Please note: All weights displayed are estimated weights and are subject to change. Dimensions are case width and do not include for handles/terminals and switches.

BPS BOXER PACKAGED SOLUTIONS - VERTICAL UNIT 22 - PERFORMANCE & TECHNICAL INFORMATION

BPS B822V (ErP 2018) NOISE DATA FOR PLATE HEAT EXCHANGER UNITS

Plate Heat Exchanger										
Fan Code	Type	63	125	250	500	1000	2000	4000	8000	(dBA@3m)
B822V	Open Discharge	73	76	81	83	84	81	77	74	48
B822V	Open Intake	67	68	77	70	67	66	62	59	
B822V	Open Supply	73	76	81	83	84	81	77	74	
B822V	Open Extract	67	68	77	70	67	66	62	59	
B822V	Breakout	73	66	72	63	57	48	40	29	

BPS B822T (ErP 2018) NOISE DATA FOR THERMAL WHEEL UNITS

Thermal Wheel										
Fan Code	Type	63	125	250	500	1000	2000	4000	8000	(dBA@3m)
B822T	Open Discharge	73	76	81	83	84	81	77	74	48
B822T	Open Intake	69	72	82	77	75	75	72	70	
B822T	Open Supply	73	76	81	83	84	81	77	74	
B822T	Open Extract	69	72	82	77	75	75	72	70	
B822T	Breakout	73	66	72	63	57	48	40	29	

THERMAL WHEEL & PLATE HEAT EXCHANGER UNITS - EFFICIENCY

B22 THERMAL WHEEL & HEAT EXCHANGER EFFICIENCY

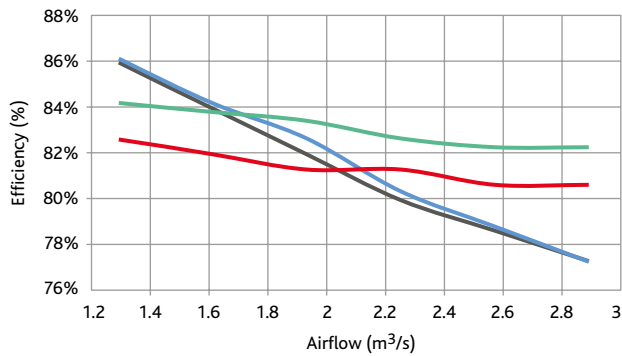

B22 THERMAL WHEEL & HEAT EXCHANGER HEAT RECOVERY

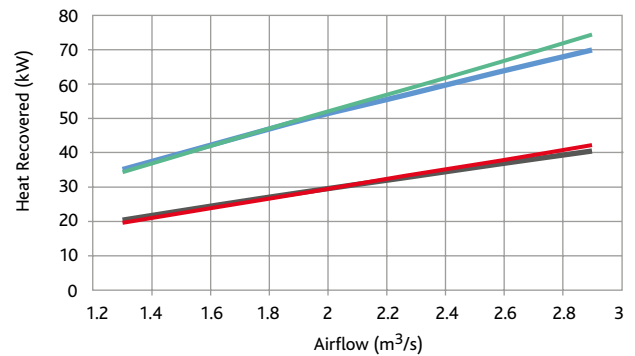

B22 THERMAL WHEEL & HEAT EXCHANGER AIR-OFF TEMPERATURES

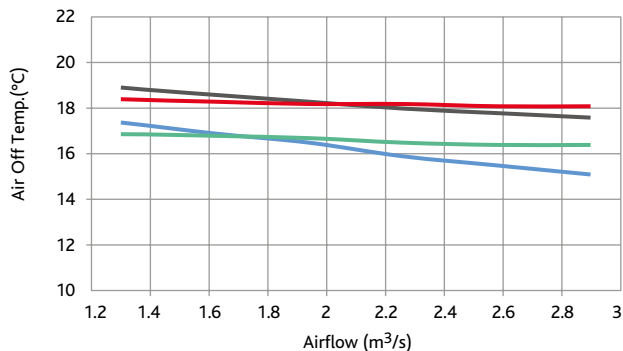

KEY:

- B822T @ 6°C Inlet
- B822T @ -5°C Inlet
- B822V @ 6°C Inlet
- B822V @ -5°C Inlet

All performance data based on indoor condition: 21°C @ 50% RH

BPS BOXER PACKAGED SOLUTIONS - VERTICAL UNIT 22 - COIL DATA

COIL DATA @ 100% SPEED

UNIT CONFIGURATION		AIR INLET CONDITION		AIR CONDITION AFTER HX		WATER PARAMETERS		AIR CONDITION AFTER COIL	
Model Code	Airflow (m³/s)	Dry bulb (°C)	Relative Humidity (%)	Dry bulb (°C)	Relative Humidity (%)	Inlet temp. (°C)	Outlet temp. (°C)	Dry bulb (°C)	Relative Humidity (%)
B822V/*R	2.5	28.0	42.9	22.7	58.6	-	-	13.3	91.8
B822V/*R	2.5	10.0	70.0	18.2	41.0	-	-	33.1	16.0
B822V/*C	2.5	28.0	42.9	22.7	58.6	6.0	12.0	13.2	92.7
B822V/*C	2.5	28.0	42.9	22.7	58.6	8.0	14.0	14.7	92.7
B822V/*C	2.5	28.0	42.9	22.7	58.6	10.0	16.0	15.6	91.2
B822V/L*	2.5	10.0	70.0	18.2	41.0	82.0	71.0	46.7	8.2
B822V/L*	2.5	10.0	70.0	18.2	41.0	80.0	60.0	41.5	10.7
B822V/L*	2.5	10.0	70.0	18.2	41.0	60.0	40.0	30.3	19.9
B822T/*R	2.5	28.0	42.9	22.4	59.7	-	-	13.2	92.0
B822T/*R	2.5	10.0	70.0	18.7	39.7	-	-	33.6	14.5
B822T/*C	2.5	28.0	42.9	22.4	59.7	6.0	12.0	13.1	92.9
B822T/*C	2.5	28.0	42.9	22.4	59.7	8.0	14.0	14.7	92.9
B822T/*C	2.5	28.0	42.9	22.4	59.7	10.0	16.0	15.6	91.5
B822T/L*	2.5	10.0	70.0	18.7	39.7	82.0	71.0	47.0	8.1
B822T/L*	2.5	10.0	70.0	18.7	39.7	80.0	60.0	41.8	10.6
B822T/L*	2.5	10.0	70.0	18.7	39.7	60.0	40.0	30.5	19.5

COIL DATA @ 75% SPEED

B822V/*R	1.9	28.0	42.9	22.7	58.8	-	-	11.6	92.8
B822V/*R	1.9	10.0	70.0	18.6	40.1	-	-	38.5	13.0
B822V/*C	1.9	28.0	42.9	22.7	58.8	6.0	12.0	12.4	94.3
B822V/*C	1.9	28.0	42.9	22.7	58.8	8.0	14.0	14.1	94.2
B822V/*C	1.9	28.0	42.9	22.7	58.8	10.0	16.0	15.0	95.1
B822V/L*	1.9	10.0	70.0	18.6	40.1	82.0	71.0	50.1	6.9
B822V/L*	1.9	10.0	70.0	18.6	40.1	80.0	60.0	44.5	9.2
B822V/L*	1.9	10.0	70.0	18.6	40.1	60.0	40.0	32.0	18.0
B822T/*R	1.9	28.0	42.9	22.2	60.5	-	-	11.3	94.1
B822T/*R	1.9	10.0	70.0	19.1	38.8	-	-	39.0	11.0
B822T/*C	1.9	28.0	42.9	22.2	60.5	6.0	12.0	12.4	94.6
B822T/*C	1.9	28.0	42.9	22.2	60.5	8.0	14.0	14.1	94.6
B822T/*C	1.9	28.0	42.9	22.2	60.5	10.0	16.0	15.0	95.2
B822T/L*	1.9	10.0	70.0	19.1	38.8	82.0	71.0	50.4	6.8
B822T/L*	1.9	10.0	70.0	19.1	38.8	80.0	60.0	44.7	9.1
B822T/L*	1.9	10.0	70.0	19.1	38.8	60.0	40.0	32.3	17.8

COIL DATA @ 50% SPEED

B822V/*R	1.3	28.0	42.9	22.6	59.1	-	-	7.8	96.4
B822V/*R	1.3	10.0	70.0	18.7	39.9	-	-	48.6	7.0
B822V/*C	1.3	28.0	42.9	22.6	59.1	6.0	12.0	11.5	96.2
B822V/*C	1.3	28.0	42.9	22.6	59.1	8.0	14.0	13.3	96.1
B822V/*C	1.3	28.0	42.9	22.6	59.1	10.0	16.0	14.2	100.0
B822V/L*	1.3	10.0	70.0	18.7	39.9	82.0	71.0	54.6	5.6
B822V/L*	1.3	10.0	70.0	18.7	39.9	80.0	60.0	48.5	7.5
B822V/L*	1.3	10.0	70.0	18.7	39.9	60.0	40.0	34.4	15.8
B822T/*R	1.3	28.0	42.9	22.0	61.4	-	-	7.5	96.8
B822T/*R	1.3	10.0	70.0	19.5	38.0	-	-	49.4	7.0
B822T/*C	1.3	28.0	42.9	22.0	61.4	6.0	12.0	11.4	96.4
B822T/*C	1.3	28.0	42.9	22.0	61.4	8.0	14.0	13.3	96.3
B822T/*C	1.3	28.0	42.9	22.0	61.4	10.0	16.0	14.2	100.0
B822T/L*	1.3	10.0	70.0	19.5	38.0	82.0	71.0	55.0	5.5
B822T/L*	1.3	10.0	70.0	19.5	38.0	80.0	60.0	48.8	7.4
B822T/L*	1.3	10.0	70.0	19.5	38.0	60.0	40.0	34.7	15.6

Note: performance is based on an indoor (or space, room etc.) condition of 21°C @ 50%RH.

	HX PERFORMANCE		DX COOLING		DX HEATING	CW COOLING		LPHW HEATING	UNIT PERFORMANCE			
	Free cooling (kW)	Heat recovery (kW)	Sensible (kW)	Gross (kW)	Capacity (kW)	Sensible (kW)	Gross (kW)	Capacity (kW)	Cooling (kW)	Heating (kW)	Water flow (l/s)	Coil Δp (kPa)
	15.9	-	28.2	37.8	-	-	-	-	44.1	-	-	-
	-	24.6	-	-	44.8	-	-	-	-	69.4	-	-
	15.9	-	-	-	-	28.6	38.4	-	44.5	-	1.5	10.5
	15.9	-	-	-	-	23.9	26.9	-	39.8	-	1.1	5.5
	15.9	-	-	-	-	21.3	21.3	-	37.2	-	0.8	3.5
	-	24.6	-	-	-	-	-	85.6	-	110.2	1.9	4.8
	-	24.6	-	-	-	-	-	69.9	-	94.5	0.8	1.1
	-	24.6	-	-	-	-	-	36.3	-	60.9	0.4	0.3
	16.8	-	27.6	37.8	-	-	-	-	44.4	-	-	-
	-	26.1	-	-	44.8	-	-	-	-	70.9	-	-
	16.8	-	-	-	-	27.8	37.7	-	44.6	-	1.5	10.2
	16.8	-	-	-	-	23.2	26.2	-	40.0	-	1.0	5.2
	16.8	-	-	-	-	20.5	20.6	-	37.3	-	0.8	3.3
	-	26.1	-	-	-	-	-	84.9	-	111.0	1.8	4.7
	-	26.1	-	-	-	-	-	69.2	-	95.3	0.8	1.1
	-	26.1	-	-	-	-	-	35.5	-	61.6	0.4	0.3

	11.9	-	25.0	37.8	-	-	-	-	36.9	-	-	-
	-	19.4	-	-	44.8	-	-	-	-	64.2	-	-
	11.9	-	-	-	-	23.1	32.6	-	35.0	-	1.3	7.8
	11.9	-	-	-	-	19.3	23.1	-	31.2	-	0.9	4.2
	11.9	-	-	-	-	17.3	17.6	-	29.2	-	0.7	2.5
	-	19.4	-	-	-	-	-	70.9	-	90.3	1.5	3.4
	-	19.4	-	-	-	-	-	58.2	-	77.6	0.7	0.8
	-	19.4	-	-	-	-	-	30.3	-	49.6	0.4	0.2
	13.1	-	24.5	37.8	-	-	-	-	37.6	-	-	-
	-	20.5	-	-	44.8	-	-	-	-	65.3	-	-
	13.1	-	-	-	-	22.1	31.6	-	35.1	-	1.3	7.4
	13.1	-	-	-	-	18.3	22.1	-	31.3	-	0.9	3.8
	13.1	-	-	-	-	16.3	16.6	-	29.3	-	0.7	2.2
	-	20.5	-	-	-	-	-	70.3	-	90.8	1.5	3.4
	-	20.5	-	-	-	-	-	57.6	-	78.1	0.7	0.8
	-	20.5	-	-	-	-	-	29.6	-	50.1	0.4	0.2

	8.1	-	22.2	37.8	-	-	-	-	30.3	-	-	-
	-	13.1	-	-	44.8	-	-	-	-	57.9	-	-
	8.1	-	-	-	-	16.7	25.1	-	24.8	-	1.0	4.9
	8.1	-	-	-	-	13.9	18.1	-	22.0	-	0.7	2.6
	8.1	-	-	-	-	12.6	13.1	-	20.7	-	0.5	1.5
	-	13.1	-	-	-	-	-	53.9	-	67.0	1.2	2.2
	-	13.1	-	-	-	-	-	44.7	-	57.8	0.5	0.5
	-	13.1	-	-	-	-	-	23.5	-	36.6	0.3	0.2
	9.0	-	21.8	37.8	-	-	-	-	30.8	-	-	-
	-	14.3	-	-	44.8	-	-	-	-	59.1	-	-
	9.0	-	-	-	-	15.9	24.4	-	24.9	-	1.0	4.6
	9.0	-	-	-	-	13.0	17.2	-	22.0	-	0.7	2.4
	9.0	-	-	-	-	11.7	12.2	-	20.7	-	0.5	1.3
	-	14.3	-	-	-	-	-	53.2	-	67.4	1.2	2.1
	-	14.3	-	-	-	-	-	44.0	-	58.2	0.5	0.5
	-	14.3	-	-	-	-	-	22.8	-	37.0	0.3	0.1

BPS BOXER PACKAGED SOLUTIONS - VERTICAL UNIT 32 - PERFORMANCE & TECHNICAL INFORMATION

BPS PERFORMANCE FOR PLATE HEAT EXCHANGER & THERMAL WHEEL UNITS

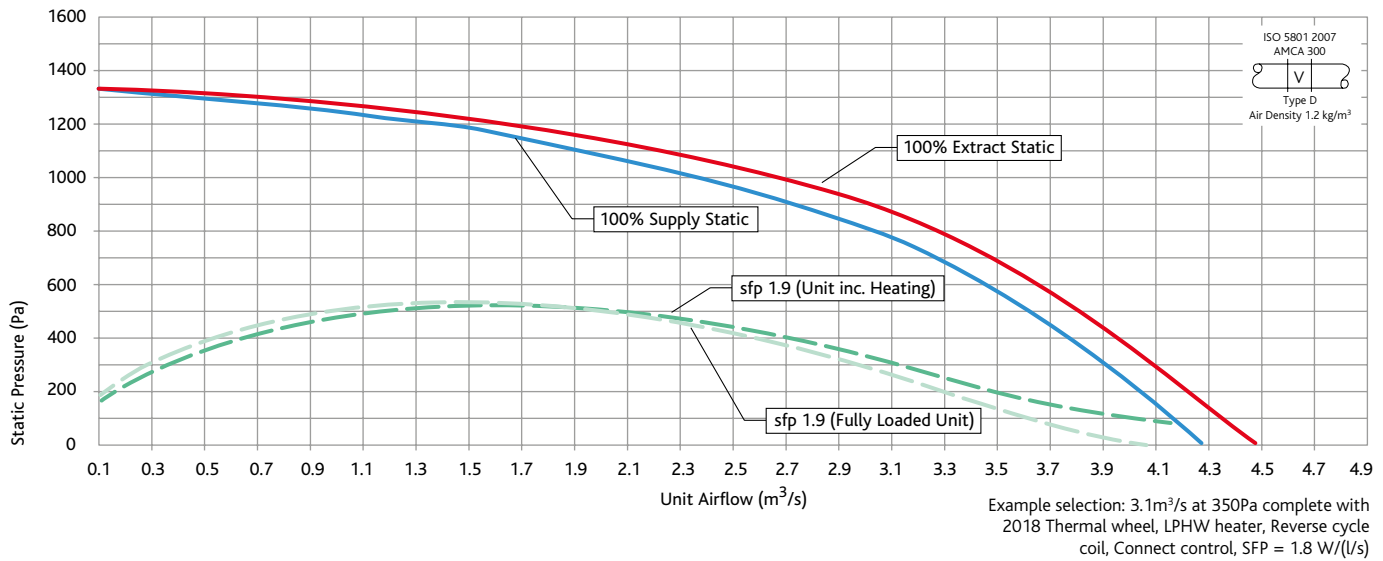

BPS TECHNICAL INFORMATION

Unit Code	Voltage / Phase / Frequency	FLC (A)	Max Operating Temperature	Fan Speed (rpm)	Unit Weight (kg)	PACKAGED WEIGHT (kg)			
						Intake Exhaust Module	PHX or Thermal Wheel Module	Supply Exhaust Module	Electric Heater Module
B832V/LR/**-#	400 / 3 / 50	19.5	40°C	1750	2147	519	932	792	-
B832V/LC/**-#	400 / 3 / 50	15	40°C	1750	2138	519	932	783	-
B832V/LN/**-#	400 / 3 / 50	15	40°C	1750	2065	519	932	710	-
B832V/ER/**-#	400 / 3 / 50	19.5 + 35 + 52.5*	40°C	1750	2473	519	932	750	392
B832V/EC/**-#	400 / 3 / 50	15 + 35 + 52.5*	40°C	1750	2464	519	932	741	392
B832V/EN/**-#	400 / 3 / 50	15 + 35 + 52.5*	40°C	1750	2391	519	932	668	392
B832V/NR/**-#	400 / 3 / 50	19.5	40°C	1750	2105	519	932	750	-
B832V/NC/**-#	400 / 3 / 50	15	40°C	1750	2096	519	932	741	-
B832V/NN/**-#	400 / 3 / 50	15	40°C	1750	2023	519	932	668	-
B832T/LR/**-#	400 / 3 / 50	19.5	40°C	1750	1908	519	690	792	-
B832T/LC/**-#	400 / 3 / 50	19	40°C	1750	1899	519	690	783	-
B832T/LN/**-#	400 / 3 / 50	19	40°C	1750	1826	519	690	710	-
B832T/ER/**-#	400 / 3 / 50	19.5 + 35 + 52.5*	40°C	1750	2234	519	690	750	392
B832T/EC/**-#	400 / 3 / 50	19 + 35 + 52.5*	40°C	1750	2225	519	690	741	392
B832T/EN/**-#	400 / 3 / 50	19 + 35 + 52.5*	40°C	1750	2152	519	690	668	392
B832T/NR/**-#	400 / 3 / 50	19.5	40°C	1750	1866	519	690	750	-
B832T/NC/**-#	400 / 3 / 50	19	40°C	1750	1857	519	690	741	-
B832T/NN/**-#	400 / 3 / 50	19	40°C	1750	1784	519	690	668	-

** Add relevant control option. i.e AT, CO, ES. # Add relevant handing. i.e L (Left) R (Right).

*FLC: Includes separate supply for 24kW and 36kW Heater elements.

Please note: All weights displayed are estimated weights and are subject to change. Dimensions are case width and do not include for handles/terminals and switches.

Unit Code	PALLET CRATE DIMENSIONS (mm)			
	Intake / Exhaust Module	PHX or Thermal Wheel Module	Supply / Exhaust Module	Electric / Heater Module
B832V/LR/**-#	1250L x 2980W x 2648H	2700L x 2980W x 2648H	1450L x 2980W x 2648H	-
B832V/LC/**-#	1250L x 2980W x 2648H	2700L x 2980W x 2648H	1450L x 2980W x 2648H	-
B832V/LN/**-#	1250L x 2980W x 2648H	2700L x 2980W x 2648H	1450L x 2980W x 2648H	-
B832V/ER/**-#	1250L x 2980W x 2648H	2700L x 2980W x 2648H	1450L x 2980W x 2648H	700L x 2980W x 2648H
B832V/EC/**-#	1250L x 2980W x 2648H	2700L x 2980W x 2648H	1450L x 2980W x 2648H	700L x 2980W x 2648H
B832V/EN/**-#	1250L x 2980W x 2648H	2700L x 2980W x 2648H	1450L x 2980W x 2648H	700L x 2980W x 2648H
B832V/NR/**-#	1250L x 2980W x 2648H	2700L x 2980W x 2648H	1450L x 2980W x 2648H	-
B832V/NC/**-#	1250L x 2980W x 2648H	2700L x 2980W x 2648H	1450L x 2980W x 2648H	-
B832V/NN/**-#	1250L x 2980W x 2648H	2700L x 2980W x 2648H	1450L x 2980W x 2648H	-
B832T/LR/**-#	1250L x 2980W x 2648H	850L x 2980W x 2648H	1450L x 2980W x 2648H	-
B832T/LC/**-#	1250L x 2980W x 2648H	850L x 2980W x 2648H	1450L x 2980W x 2648H	-
B832T/LN/**-#	1250L x 2980W x 2648H	850L x 2980W x 2648H	1450L x 2980W x 2648H	-
B832T/ER/**-#	1250L x 2980W x 2648H	850L x 2980W x 2648H	1450L x 2980W x 2648H	700L x 2980W x 2648H
B832T/EC/**-#	1250L x 2980W x 2648H	850L x 2980W x 2648H	1450L x 2980W x 2648H	700L x 2980W x 2648H
B832T/EN/**-#	1250L x 2980W x 2648H	850L x 2980W x 2648H	1450L x 2980W x 2648H	700L x 2980W x 2648H
B832T/NR/**-#	1250L x 2980W x 2648H	850L x 2980W x 2648H	1450L x 2980W x 2648H	-
B832T/NC/**-#	1250L x 2980W x 2648H	850L x 2980W x 2648H	1450L x 2980W x 2648H	-
B832T/NN/**-#	1250L x 2980W x 2648H	850L x 2980W x 2648H	1450L x 2980W x 2648H	-

** Add relevant control option. i.e AT, CO, ES. # Add relevant handing. i.e L (Left) R (Right).

Please note: All weights displayed are estimated weights and are subject to change. Dimensions are case width and do not include for handles/terminals and switches.

BPS BOXER PACKAGED SOLUTIONS - VERTICAL UNIT 32 - PERFORMANCE & TECHNICAL INFORMATION

BPS B832V (ErP 2018) NOISE DATA FOR PLATE HEAT EXCHANGER UNITS

Plate Heat Exchanger										
Fan Code	Type	63	125	250	500	1000	2000	4000	8000	(dBA@3m)
B832V	Open Discharge	75	78	89	86	90	86	82	80	52
B832V	Open Intake	70	69	77	71	71	71	67	67	
B832V	Open Supply	75	78	89	86	90	86	82	80	
B832V	Open Extract	70	69	77	71	71	71	67	67	
B832V	Breakout	75	67	77	66	63	52	45	36	

BPS B832T (ErP 2018) NOISE DATA FOR THERMAL WHEEL UNITS

Thermal Wheel										
Fan Code	Type	63	125	250	500	1000	2000	4000	8000	(dBA@3m)
B832T	Open Discharge	75	78	89	86	90	86	82	80	52
B832T	Open Intake	72	73	83	78	79	80	78	78	
B832T	Open Supply	75	78	89	86	90	86	82	80	
B832T	Open Extract	72	73	83	78	79	80	78	78	
B832T	Breakout	75	67	77	66	63	52	45	36	

THERMAL WHEEL & PLATE HEAT EXCHANGER UNITS - EFFICIENCY

B32 THERMAL WHEEL & HEAT EXCHANGER EFFICIENCY

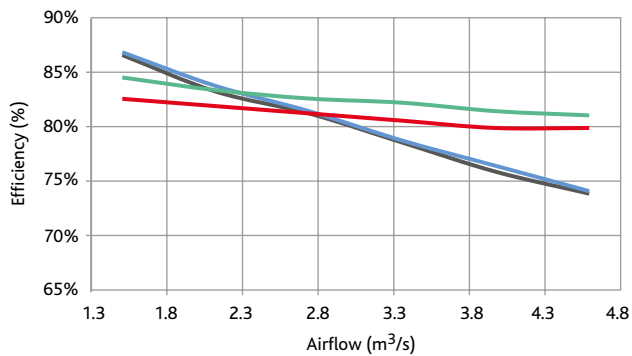

B32 THERMAL WHEEL & HEAT EXCHANGER HEAT RECOVERY

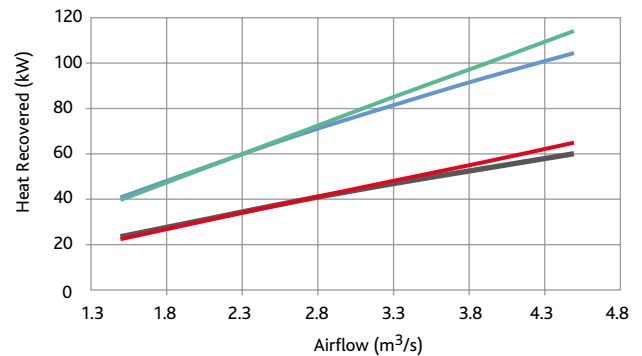

B32 THERMAL WHEEL & HEAT EXCHANGER AIR-OFF TEMPERATURES

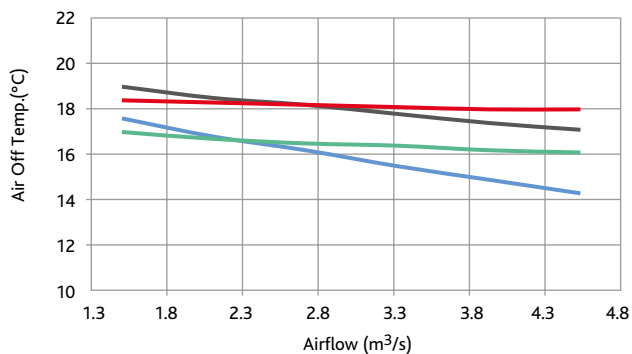

KEY:

- B832T @ 6°C Inlet
- B832T @ -5°C Inlet
- B832V @ 6°C Inlet
- B832V @ -5°C Inlet

All performance data based on indoor condition: 21°C @ 50% RH

BPS BOXER PACKAGED SOLUTIONS - VERTICAL UNIT 32 - COIL DATA

COIL DATA @ 100% SPEED

UNIT CONFIGURATION		AIR INLET CONDITION		AIR CONDITION AFTER HX		WATER PARAMETERS		AIR CONDITION AFTER COIL	
Model Code	Airflow (m³/s)	Dry bulb (°C)	Relative Humidity (%)	Dry bulb (°C)	Relative Humidity (%)	Inlet temp. (°C)	Outlet temp. (°C)	Dry bulb (°C)	Relative Humidity (%)
B832V/*R	3.9	28.0	42.9	22.8	58.2	-	-	13.6	90.7
B832V/*R	3.9	10.0	70.0	18.1	41.3	-	-	32.5	17.0
B832V/*C	3.9	28.0	42.9	22.8	58.2	6.0	12.0	13.4	91.8
B832V/*C	3.9	28.0	42.9	22.8	58.2	8.0	14.0	14.9	91.7
B832V/*C	3.9	28.0	42.9	22.8	58.2	10.0	16.0	15.7	90.4
B832V/L*	3.9	10.0	70.0	18.1	41.3	82.0	71.0	45.4	8.8
B832V/L*	3.9	10.0	70.0	18.1	41.3	80.0	60.0	40.6	11.3
B832V/L*	3.9	10.0	70.0	18.1	41.3	60.0	40.0	30.0	20.2
B832T/*R	3.9	28.0	42.9	22.6	58.9	-	-	13.6	90.9
B832T/*R	3.9	10.0	70.0	18.4	40.5	-	-	32.8	16.0
B832T/*C	3.9	28.0	42.9	22.6	58.9	6.0	12.0	13.3	92.0
B832T/*C	3.9	28.0	42.9	22.6	58.9	8.0	14.0	14.8	91.9
B832T/*C	3.9	28.0	42.9	22.6	58.9	10.0	16.0	15.7	90.6
B832T/L*	3.9	10.0	70.0	18.4	40.5	82.0	71.0	45.5	8.7
B832T/L*	3.9	10.0	70.0	18.4	40.5	80.0	60.0	40.8	11.2
B832T/L*	3.9	10.0	70.0	18.4	40.5	60.0	40.0	30.2	20.0

COIL DATA @ 75% SPEED

B832V/*R	2.9	28.0	42.9	22.8	58.5	-	-	11.7	93.0
B832V/*R	2.9	10.0	70.0	18.2	41.1	-	-	37.3	12.0
B832V/*C	2.9	28.0	42.9	22.8	58.5	6.0	12.0	12.6	93.7
B832V/*C	2.9	28.0	42.9	22.8	58.5	8.0	14.0	14.2	93.6
B832V/*C	2.9	28.0	42.9	22.8	58.5	10.0	16.0	15.1	94.8
B832V/L*	2.9	10.0	70.0	18.2	41.1	82.0	71.0	48.8	7.4
B832V/L*	2.9	10.0	70.0	18.2	41.1	80.0	60.0	43.6	9.6
B832V/L*	2.9	10.0	70.0	18.2	41.1	60.0	40.0	31.8	18.3
B832T/*R	2.9	28.0	42.9	22.4	60.0	-	-	11.5	93.3
B832T/*R	2.9	10.0	70.0	18.8	39.4	-	-	37.9	11.0
B832T/*C	2.9	28.0	42.9	22.4	60.0	6.0	12.0	12.5	94.0
B832T/*C	2.9	28.0	42.9	22.4	60.0	8.0	14.0	14.1	93.9
B832T/*C	2.9	28.0	42.9	22.4	60.0	10.0	16.0	15.0	95.2
B832T/L*	2.9	10.0	70.0	18.8	39.4	82.0	71.0	49.1	7.2
B832T/L*	2.9	10.0	70.0	18.8	39.4	80.0	60.0	43.9	9.4
B832T/L*	2.9	10.0	70.0	18.8	39.4	60.0	40.0	32.0	17.9

COIL DATA @ 50% SPEED

B832V/*R	2.0	28.0	42.9	22.7	58.7	-	-	8.1	95.8
B832V/*R	2.0	10.0	70.0	18.3	40.8	-	-	47.0	7.0
B832V/*C	2.0	28.0	42.9	22.7	58.7	6.0	12.0	11.5	95.6
B832V/*C	2.0	28.0	42.9	22.7	58.7	8.0	14.0	13.4	95.5
B832V/*C	2.0	28.0	42.9	22.7	58.7	10.0	16.0	14.3	99.6
B832V/L*	2.0	10.0	70.0	18.3	40.8	82.0	71.0	53.3	5.9
B832V/L*	2.0	10.0	70.0	18.3	40.8	80.0	60.0	47.6	7.8
B832V/L*	2.0	10.0	70.0	18.3	40.8	60.0	40.0	34.1	16.0
B832T/*R	2.0	28.0	42.9	22.1	61.0	-	-	7.9	96.2
B832T/*R	2.0	10.0	70.0	19.3	38.4	-	-	48.0	6.0
B832T/*C	2.0	28.0	42.9	22.1	61.0	6.0	12.0	11.5	95.9
B832T/*C	2.0	28.0	42.9	22.1	61.0	8.0	14.0	13.4	95.8
B832T/*C	2.0	28.0	42.9	22.1	61.0	10.0	16.0	14.2	99.9
B832T/L*	2.0	10.0	70.0	19.3	38.4	82.0	71.0	53.7	5.8
B832T/L*	2.0	10.0	70.0	19.3	38.4	80.0	60.0	48.0	7.7
B832T/L*	2.0	10.0	70.0	19.3	38.4	60.0	40.0	34.5	15.7

Note: performance is based on an indoor (or space, room etc.) condition of 21°C @ 50%RH.

	HX PERFORMANCE		DX COOLING		DX HEATING	CW COOLING		LPHW HEATING	UNIT PERFORMANCE			
	Free cooling (kW)	Heat recovery (kW)	Sensible (kW)	Gross (kW)	Capacity (kW)	Sensible (kW)	Gross (kW)	Capacity (kW)	Cooling (kW)	Heating (kW)	Water flow (l/s)	Coil Δp (kPa)
	24.3	-	43.1	57.0	-	-	-	-	67.4	-	-	-
	-	37.9	-	-	67.2	-	-	-	-	105.1	-	-
	24.3	-	-	-	-	44.1	59.0	-	68.4	-	2.3	21.4
	24.3	-	-	-	-	37.2	41.9	-	61.5	-	1.7	11.3
	24.3	-	-	-	-	33.1	33.1	-	57.4	-	1.3	7.3
	-	37.9	-	-	-	-	-	127.6	-	165.6	2.8	9.9
	-	37.9	-	-	-	-	-	105.3	-	143.2	1.3	2.3
	-	37.9	-	-	-	-	-	55.7	-	93.6	0.7	0.7
	25.3	-	42.1	57.0	-	-	-	-	67.4	-	-	-
	-	39.3	-	-	67.2	-	-	-	-	106.5	-	-
	25.3	-	-	-	-	43.3	58.3	-	68.6	-	2.3	20.9
	25.3	-	-	-	-	36.4	41.1	-	61.7	-	1.6	11.0
	25.3	-	-	-	-	32.3	32.4	-	57.6	-	1.3	7.0
	-	39.3	-	-	-	-	-	127.0	-	166.3	2.8	9.8
	-	39.3	-	-	-	-	-	104.6	-	143.9	1.2	2.3
	-	39.3	-	-	-	-	-	55.1	-	94.4	0.7	0.7

	18.3	-	39.0	57.0	-	-	-	-	57.2	-	-	-
	-	28.8	-	-	67.2	-	-	-	-	96.0	-	-
	18.3	-	-	-	-	36.0	49.7	-	54.2	-	2.0	15.6
	18.3	-	-	-	-	30.2	35.7	-	48.4	-	1.4	8.5
	18.3	-	-	-	-	27.1	27.0	-	45.4	-	1.1	5.0
	-	28.8	-	-	-	-	-	107.6	-	136.3	2.3	7.1
	-	28.8	-	-	-	-	-	89.3	-	118.0	1.1	1.7
	-	28.8	-	-	-	-	-	47.6	-	76.4	0.6	0.5
	19.7	-	38.3	57.0	-	-	-	-	57.9	-	-	-
	-	30.9	-	-	67.2	-	-	-	-	98.1	-	-
	19.7	-	-	-	-	34.7	48.7	-	54.4	-	1.9	15.1
	19.7	-	-	-	-	29.0	34.7	-	48.6	-	1.4	8.0
	19.7	-	-	-	-	25.9	25.7	-	45.5	-	1.0	4.6
	-	30.9	-	-	-	-	-	106.5	-	137.4	2.3	6.9
	-	30.9	-	-	-	-	-	88.2	-	119.1	1.1	1.6
	-	30.9	-	-	-	-	-	46.5	-	77.4	0.6	0.5

	12.4	-	34.2	57.0	-	-	-	-	46.6	-	-	-
	-	19.4	-	-	67.2	-	-	-	-	86.6	-	-
	12.4	-	-	-	-	26.1	38.6	-	38.5	-	1.5	9.9
	12.4	-	-	-	-	21.8	28.0	-	34.2	-	1.1	5.4
	12.4	-	-	-	-	19.7	20.3	-	32.1	-	0.8	3.0
	-	19.4	-	-	-	-	-	81.9	-	101.3	1.8	4.5
	-	19.4	-	-	-	-	-	68.6	-	88.0	0.8	1.1
	-	19.4	-	-	-	-	-	37.0	-	56.4	0.4	0.4
	13.8	-	33.2	57.0	-	-	-	-	47.0	-	-	-
	-	21.8	-	-	67.2	-	-	-	-	89.0	-	-
	13.8	-	-	-	-	24.8	37.5	-	38.6	-	1.5	9.3
	13.8	-	-	-	-	20.5	26.8	-	34.3	-	1.1	5.0
	13.8	-	-	-	-	18.4	18.9	-	32.2	-	0.8	2.6
	-	21.8	-	-	-	-	-	80.6	-	102.3	1.7	4.4
	-	21.8	-	-	-	-	-	67.2	-	89.0	0.8	1.0
	-	21.8	-	-	-	-	-	35.5	-	57.3	0.4	0.3

BPS BOXER PACKAGED SOLUTIONS - VERTICAL UNIT 42 - PERFORMANCE & TECHNICAL INFORMATION

BPS PERFORMANCE FOR PLATE HEAT EXCHANGER & THERMAL WHEEL UNITS

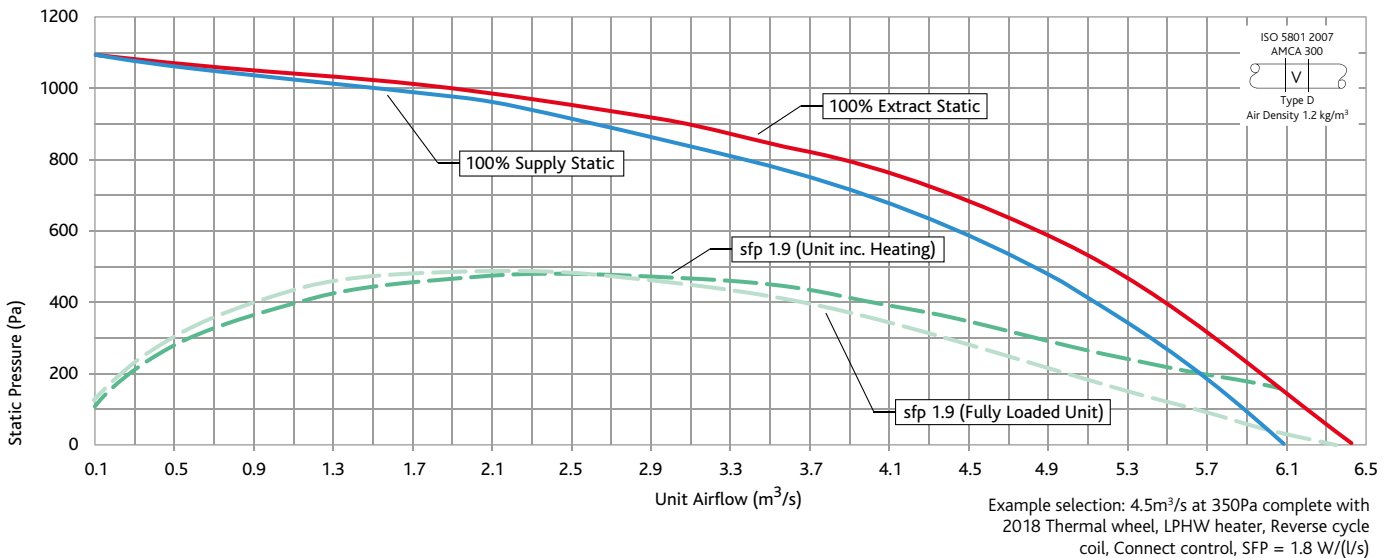

BPS TECHNICAL INFORMATION

Unit Code	Voltage/Phase/Frequency	FLC (A)	Max Operating Temperature	Fan Speed (rpm)	Unit Weight (kg)	PACKAGED WEIGHT (kg)			
						Intake Exhaust Module	PHX or Thermal Wheel Module	Supply Exhaust Module	Electric Heater Module
B842V/LR/**-#	400 / 3 / 50	23	40°C	1780	2915	652	1386	973	-
B842V/LC/**-#	400 / 3 / 50	18.5	40°C	1780	2925	652	1386	983	-
B842V/LN/**-#	400 / 3 / 50	18.5	40°C	1780	2825	652	1386	883	-
B842V/ER/**-#	400 / 3 / 50	23 + 52.5 + 52.5*	40°C	1780	3261	652	1386	913	430
B842V/EC/**-#	400 / 3 / 50	18.5 + 52.5 + 52.5*	40°C	1780	3271	652	1386	923	430
B842V/EN/**-#	400 / 3 / 50	18.5 + 52.5 + 52.5*	40°C	1780	3171	652	1386	823	430
B842V/NR/**-#	400 / 3 / 50	23	40°C	1780	2855	652	1386	913	-
B842V/NC/**-#	400 / 3 / 50	18.5	40°C	1780	2865	652	1386	923	-
B842V/NN/**-#	400 / 3 / 50	18.5	40°C	1780	2765	652	1386	823	-
B842T/LR/**-#	400 / 3 / 50	27	40°C	1780	2385	652	853	973	-
B842T/LC/**-#	400 / 3 / 50	22.5	40°C	1780	2395	652	853	983	-
B842T/LN/**-#	400 / 3 / 50	22.5	40°C	1780	2295	652	853	883	-
B842T/ER/**-#	400 / 3 / 50	27 + 52.5 + 52.5*	40°C	1780	2731	652	853	913	430
B842T/EC/**-#	400 / 3 / 50	22.5 + 52.5 + 52.5*	40°C	1780	2741	652	853	923	430
B842T/EN/**-#	400 / 3 / 50	22.5 + 52.5 + 52.5*	40°C	1780	2641	652	853	823	430
B842T/NR/**-#	400 / 3 / 50	27	40°C	1780	2325	652	853	913	-
B842T/NC/**-#	400 / 3 / 50	22.5	40°C	1780	2335	652	853	923	-
B842T/NN/**-#	400 / 3 / 50	22.5	40°C	1780	2235	652	853	823	-

** Add relevant control option. i.e AT, CO, ES. # Add relevant handing. i.e L (Left) R (Right).

*Includes separate supply for two 36kW heater elements.

*** Please note: All weights displayed are estimated weights and are subject to change. Dimensions are case width and do not include for handles/terminals and switches.

Unit Code	PALLET CRATE DIMENSIONS (mm)			
	Intake / Exhaust Module	PHX or Thermal Wheel Module	Supply / Exhaust Module	Electric / Heater Module
B842V/LR/**-#	1250L x 2980W x 3048H	2700L x 2980W x 3048H	1450L x 2980W x 3048H	-
B842V/LC/**-#	1250L x 2980W x 3048H	2700L x 2980W x 3048H	1450L x 2980W x 3048H	-
B842V/LN/**-#	1250L x 2980W x 3048H	2700L x 2980W x 3048H	1450L x 2980W x 3048H	-
B842V/ER/**-#	1250L x 2980W x 3048H	2700L x 2980W x 3048H	1450L x 2980W x 3048H	700L x 2980W x 3048H
B842V/EC/**-#	1250L x 2980W x 3048H	2700L x 2980W x 3048H	1450L x 2980W x 3048H	700L x 2980W x 3048H
B842V/EN/**-#	1250L x 2980W x 3048H	2700L x 2980W x 3048H	1450L x 2980W x 3048H	700L x 2980W x 3048H
B842V/NR/**-#	1250L x 2980W x 3048H	2700L x 2980W x 3048H	1450L x 2980W x 3048H	-
B842V/NC/**-#	1250L x 2980W x 3048H	2700L x 2980W x 3048H	1450L x 2980W x 3048H	-
B842V/NN/**-#	1250L x 2980W x 3048H	2700L x 2980W x 3048H	1450L x 2980W x 3048H	-
B842T/LR/**-#	1250L x 2980W x 3048H	850L x 2980W x 3048H	1450L x 2980W x 3048H	-
B842T/LC/**-#	1250L x 2980W x 3048H	850L x 2980W x 3048H	1450L x 2980W x 3048H	-
B842T/LN/**-#	1250L x 2980W x 3048H	850L x 2980W x 3048H	1450L x 2980W x 3048H	-
B842T/ER/**-#	1250L x 2980W x 3048H	850L x 2980W x 3048H	1450L x 2980W x 3048H	700L x 2980W x 3048H
B842T/EC/**-#	1250L x 2980W x 3048H	850L x 2980W x 3048H	1450L x 2980W x 3048H	700L x 2980W x 3048H
B842T/EN/**-#	1250L x 2980W x 3048H	850L x 2980W x 3048H	1450L x 2980W x 3048H	700L x 2980W x 3048H
B842T/NR/**-#	1250L x 2980W x 3048H	850L x 2980W x 3048H	1450L x 2980W x 3048H	-
B842T/NC/**-#	1250L x 2980W x 3048H	850L x 2980W x 3048H	1450L x 2980W x 3048H	-
B842T/NN/**-#	1250L x 2980W x 3048H	850L x 2980W x 3048H	1450L x 2980W x 3048H	-

** Add relevant control option. i.e AT, CO, ES. # Add relevant handing. i.e L (Left) R (Right).

*** Please note: All weights displayed are estimated weights and are subject to change. Dimensions are case width and do not include for handles/terminals and switches.

BPS BOXER PACKAGED SOLUTIONS - VERTICAL UNIT 42 - PERFORMANCE & TECHNICAL INFORMATION

BPS B842V (ErP 2018) NOISE DATA FOR PLATE HEAT EXCHANGER UNITS

Plate Heat Exchanger										
Fan Code	Type	63	125	250	500	1000	2000	4000	8000	(dBA@3m)
B842V	Open Discharge	76	79	84	86	87	84	80	77	51
B842V	Open Intake	69	71	79	72	69	68	64	61	
B842V	Open Supply	76	79	84	86	87	84	80	77	
B842V	Open Extract	69	71	79	72	69	68	64	61	
B842V	Breakout	76	69	75	66	60	51	43	32	

BPS B842T (ErP 2018) NOISE DATA FOR THERMAL WHEEL UNITS

Thermal Wheel										
Fan Code	Type	63	125	250	500	1000	2000	4000	8000	(dBA@3m)
B842T	Open Discharge	76	79	84	86	87	84	80	77	51
B842T	Open Intake	72	75	85	80	78	78	75	73	
B842T	Open Supply	76	79	84	86	87	84	80	77	
B842T	Open Extract	72	75	85	80	78	78	75	73	
B842T	Breakout	76	69	75	66	60	51	43	32	

THERMAL WHEEL & PLATE HEAT EXCHANGER UNITS - EFFICIENCY

B42 THERMAL WHEEL & HEAT EXCHANGER EFFICIENCY

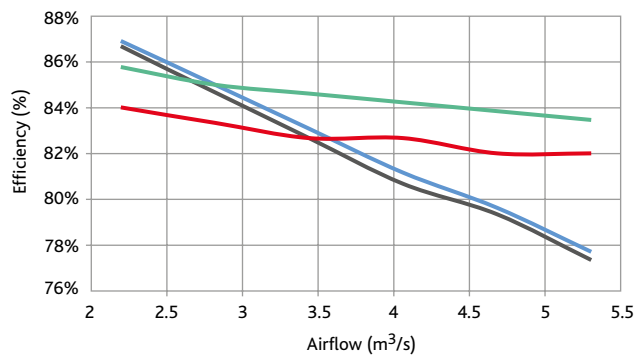

B42 THERMAL WHEEL & HEAT EXCHANGER HEAT RECOVERY

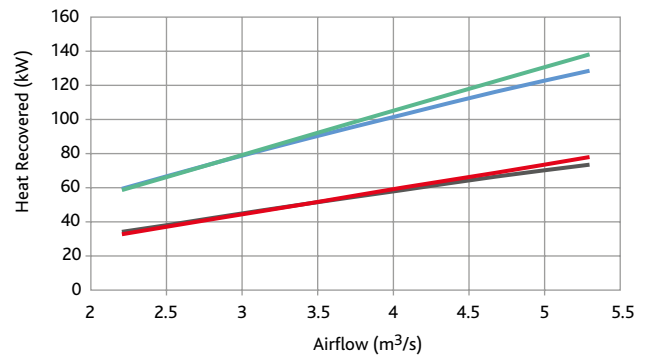

B42 THERMAL WHEEL & HEAT EXCHANGER AIR-OFF TEMPERATURES

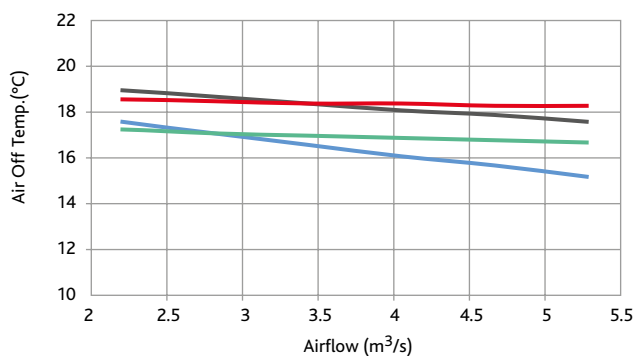

KEY:

- B842T @ 6°C Inlet
- B842T @ -5°C Inlet
- B842V @ 6°C Inlet
- B842V @ -5°C Inlet

All performance data based on indoor condition: 21°C @ 50% RH

BPS BOXER PACKAGED SOLUTIONS - VERTICAL UNIT 42 - COIL DATA

COIL DATA @ 100% SPEED

UNIT CONFIGURATION		AIR INLET CONDITION		AIR CONDITION AFTER HX		WATER PARAMETERS		AIR CONDITION AFTER COIL	
Model Code	Airflow (m³/s)	Dry bulb (°C)	Relative Humidity (%)	Dry bulb (°C)	Relative Humidity (%)	Inlet temp. (°C)	Outlet temp. (°C)	Dry bulb (°C)	Relative Humidity (%)
B842V/*R	5.4	28.0	2.9	22.7	58.5	-	-	14.4	91.2
B842V/*R	5.4	10.0	70.0	18.2	41.1	-	-	30.7	20.0
B842V/*C	5.4	28.0	42.9	22.7	58.5	6.0	12.0	13.2	91.9
B842V/*C	5.4	28.0	42.9	22.7	58.5	8.0	14.0	14.7	91.8
B842V/*C	5.4	28.0	42.9	22.7	58.5	10.0	16.0	15.5	91.5
B842V/L*	5.4	10.0	70.0	18.2	41.1	82.0	71.0	45.7	8.7
B842V/L*	5.4	10.0	70.0	18.2	41.1	80.0	60.0	41.1	11.0
B842V/L*	5.4	10.0	70.0	18.2	41.1	60.0	40.0	30.6	19.6
B842T/*R	5.3	28.0	42.9	22.5	59.2	-	-	14.2	91.5
B842T/*R	5.3	10.0	70.0	18.6	40.1	-	-	31.3	19.0
B842T/*C	5.3	28.0	42.9	22.5	59.2	6.0	12.0	13.1	92.2
B842T/*C	5.3	28.0	42.9	22.5	59.2	8.0	14.0	14.6	92.1
B842T/*C	5.3	28.0	42.9	22.5	59.2	10.0	16.0	15.5	91.9
B842T/L*	5.3	10.0	70.0	18.6	40.1	82.0	71.0	46.1	8.5
B842T/L*	5.3	10.0	70.0	18.6	40.1	80.0	60.0	41.5	10.7
B842T/L*	5.3	10.0	70.0	18.6	40.1	60.0	40.0	30.9	19.2

COIL DATA @ 75% SPEED

B842V/*R	4.1	28.0	42.9	22.7	58.7	-	-	12.9	93.1
B842V/*R	4.1	10.0	70.0	18.6	40.1	-	-	35.3	15.0
B842V/*C	4.1	28.0	42.9	22.7	58.7	6.0	12.0	12.4	93.6
B842V/*C	4.1	28.0	42.9	22.7	58.7	8.0	14.0	14.0	93.5
B842V/*C	4.1	28.0	42.9	22.7	58.7	10.0	16.0	14.9	95.5
B842V/L*	4.1	10.0	70.0	18.6	40.1	82.0	71.0	49.0	7.3
B842V/L*	4.1	10.0	70.0	18.6	40.1	80.0	60.0	44.1	9.4
B842V/L*	4.1	10.0	70.0	18.6	40.1	60.0	40.0	32.4	17.6
B842T/*R	4.0	28.0	42.9	22.3	60.2	-	-	12.6	93.6
B842T/*R	4.0	10.0	70.0	19.0	39.2	-	-	36.0	14.0
B842T/*C	4.0	28.0	42.9	22.3	60.2	6.0	12.0	12.3	94.1
B842T/*C	4.0	28.0	42.9	22.3	60.2	8.0	14.0	13.9	93.9
B842T/*C	4.0	28.0	42.9	22.3	60.2	10.0	16.0	14.8	96.2
B842T/L*	4.0	10.0	70.0	19.0	39.2	82.0	71.0	49.5	7.1
B842T/L*	4.0	10.0	70.0	19.0	39.2	80.0	60.0	44.6	9.2
B842T/L*	4.0	10.0	70.0	19.0	39.2	60.0	40.0	32.7	17.4

COIL DATA @ 50% SPEED

B842V/*R	2.7	28.0	42.9	22.6	59.0	-	-	9.6	95.7
B842V/*R	2.7	10.0	70.0	18.7	39.9	-	-	43.7	9.0
B842V/*C	2.7	28.0	42.9	22.6	59.0	6.0	12.0	11.3	95.7
B842V/*C	2.7	28.0	42.9	22.6	59.0	8.0	14.0	13.1	95.7
B842V/*C	2.7	28.0	42.9	22.6	59.0	10.0	16.0	14.0	100.0
B842V/L*	2.7	10.0	70.0	18.7	39.9	82.0	71.0	54.0	5.7
B842V/L*	2.7	10.0	70.0	18.7	39.9	80.0	60.0	48.6	7.5
B842V/L*	2.7	10.0	70.0	18.7	39.9	60.0	40.0	35.1	15.2
B842T/*R	2.7	28.0	42.9	22.0	61.2	-	-	9.3	96.1
B842T/*R	2.7	10.0	70.0	19.4	38.2	-	-	44.9	8.0
B842T/*C	2.7	28.0	42.9	22.0	61.2	6.0	12.0	11.2	96.0
B842T/*C	2.7	28.0	42.9	22.0	61.2	8.0	14.0	13.1	95.9
B842T/*C	2.7	28.0	42.9	22.0	61.2	10.0	16.0	14.0	100.0
B842T/L*	2.7	10.0	70.0	19.4	38.2	82.0	71.0	54.3	5.6
B842T/L*	2.7	10.0	70.0	19.4	38.2	80.0	60.0	48.9	7.4
B842T/L*	2.7	10.0	70.0	19.4	38.2	60.0	40.0	35.3	15.0

Note: performance is based on an indoor (or space, room etc.) condition of 21°C @ 50%RH.

	HX PERFORMANCE		DX COOLING		DX HEATING	CW COOLING		LPHW HEATING	UNIT PERFORMANCE			
	Free cooling (kW)	Heat recovery (kW)	Sensible (kW)	Gross (kW)	Capacity (kW)	Sensible (kW)	Gross (kW)	Capacity (kW)	Cooling (kW)	Heating (kW)	Water flow (l/s)	Coil Δp (kPa)
	34.3	-	53.8	66.0	-	-	-	-	88.1	-	-	-
	-	53.1	-	-	81.0	-	-	-	-	134.1	-	-
	34.3	-	-	-	-	61.8	84.1	-	96.1	-	3.3	40.3
	34.3	-	-	-	-	52.1	60.3	-	86.4	-	2.4	21.7
	34.3	-	-	-	-	46.5	46.6	-	80.8	-	1.9	13.5
	-	53.1	-	-	-	-	-	177.9	-	231.0	3.9	18.9
	-	53.1	-	-	-	-	-	148.5	-	201.6	1.8	4.5
	-	53.1	-	-	-	-	-	80.3	-	133.5	1.0	1.5
	35.0	-	52.8	66.0	-	-	-	-	87.8	-	-	-
	-	54.7	-	-	81.0	-	-	-	-	135.7	-	-
	35.0	-	-	-	-	59.9	82.2	-	94.9	-	3.3	38.7
	35.0	-	-	-	-	50.4	58.7	-	85.3	-	2.3	20.7
	35.0	-	-	-	-	44.8	45.0	-	79.8	-	1.8	12.6
	-	54.7	-	-	-	-	-	174.8	-	229.5	3.8	18.3
	-	54.7	-	-	-	-	-	145.8	-	200.5	1.7	4.3
	-	54.7	-	-	-	-	-	78.3	-	133.0	0.9	1.4

	25.8	-	47.6	66.0	-	-	-	-	73.4	-	-	-
	-	41.8	-	-	81.0	-	-	-	-	122.8	-	-
	25.8	-	-	-	-	50.1	71.5	-	75.9	-	2.8	30.0
	25.8	-	-	-	-	42.1	51.8	-	67.8	-	2.1	16.5
	25.8	-	-	-	-	37.8	38.4	-	63.6	-	1.5	9.5
	-	41.8	-	-	-	-	-	148.0	-	189.8	3.2	13.7
	-	41.8	-	-	-	-	-	124.0	-	165.8	1.5	3.3
	-	41.8	-	-	-	-	-	67.1	-	108.9	0.8	1.1
	27.2	-	46.3	66.0	-	-	-	-	73.5	-	-	-
	-	42.9	-	-	81.0	-	-	-	-	123.9	-	-
	27.2	-	-	-	-	47.9	68.9	-	75.0	-	2.7	28.1
	27.2	-	-	-	-	39.9	49.5	-	67.1	-	2.0	15.2
	27.2	-	-	-	-	35.7	36.1	-	62.9	-	1.4	8.4
	-	42.9	-	-	-	-	-	145.6	-	188.6	3.2	13.1
	-	42.9	-	-	-	-	-	122.0	-	164.9	1.5	3.1
	-	42.9	-	-	-	-	-	65.6	-	108.5	0.8	1.0

	17.5	-	42.0	66.0	-	-	-	-	59.5	-	-	-
	-	28.2	-	-	81.0	-	-	-	-	109.2	-	-
	17.5	-	-	-	-	36.8	53.8	-	54.3	-	2.1	17.9
	17.5	-	-	-	-	30.7	39.5	-	48.2	-	1.6	10.1
	17.5	-	-	-	-	27.8	27.9	-	45.3	-	1.1	5.3
	-	28.2	-	-	-	-	-	114.5	-	142.7	2.5	8.3
	-	28.2	-	-	-	-	-	96.9	-	125.1	1.2	2.0
	-	28.2	-	-	-	-	-	53.0	-	81.2	0.6	0.7
	19.1	-	40.3	66.0	-	-	-	-	59.3	-	-	-
	-	29.9	-	-	81.0	-	-	-	-	110.9	-	-
	19.1	-	-	-	-	34.3	52.1	-	53.4	-	2.1	16.9
	19.1	-	-	-	-	28.3	37.7	-	47.4	-	1.5	9.2
	19.1	-	-	-	-	25.4	26.0	-	44.5	-	1.0	4.7
	-	29.9	-	-	-	-	-	111.1	-	141.0	2.4	8.1
	-	29.9	-	-	-	-	-	93.8	-	123.7	1.1	2.0
	-	29.9	-	-	-	-	-	50.6	-	80.5	0.6	0.7

BPS BOXER PACKAGED SOLUTIONS - VERTICAL UNIT - HANDINGS & AIRFLOW

BPS VERTICAL PLATE HEAT EXCHANGER UNIT



▲ Model shown is left hand.

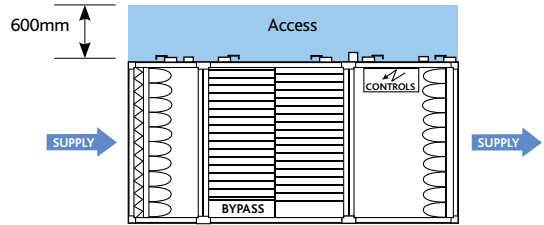

Shown from top (left hand -L).



▲ Model shown is right hand.

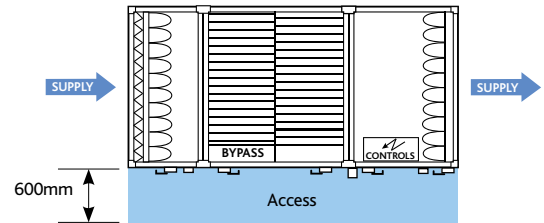

Shown from top (right hand -R).

BPS THERMAL WHEEL UNIT



▲ Model shown is left hand.

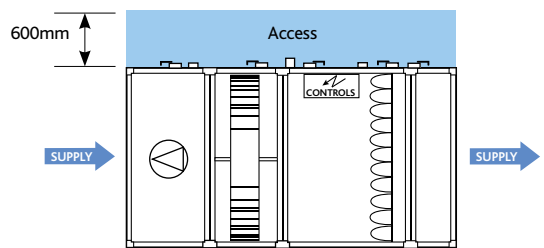

Shown from top (left hand -L).



▲ Model shown is right hand.

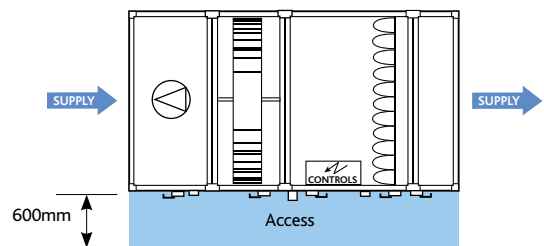

Shown from top (right hand -R).

BPS BOXER PACKAGED SOLUTIONS - VERTICAL UNIT - DIMENSIONS & AIRFLOW

BPS DIMENSIONS FOR VERTICAL PLATE HEAT EXCHANGER UNIT (mm)

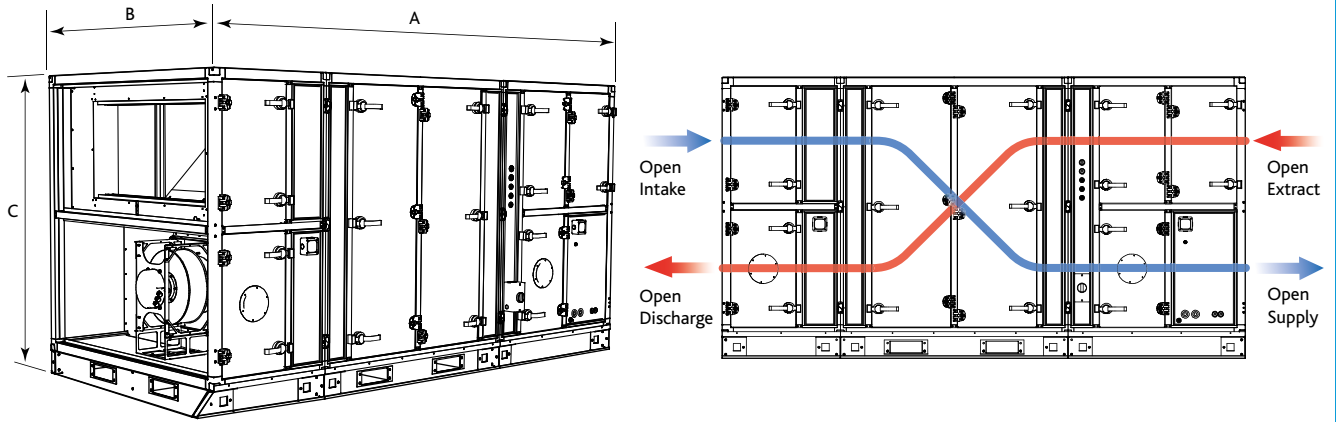

▲ Model shown is right hand.

Plate Heat Exchanger					
Unit	Unit	A	A*	B	C
Plate HX	07	3150	3600	1330	1492
Plate HX	12	3355	3805	1530	1695
Plate HX	17	3540	3990	1750	1900
Plate HX	22	3950	4400	2030	2195
Plate HX	32	4230	4780	2330	2498
Plate HX	42	4950	5500	2730	2898

*Electric Heater is included.
Dimension 'A' is for LPHW or No heating.

BPS DIMENSIONS FOR VERTICAL THERMAL WHEEL UNIT (mm)

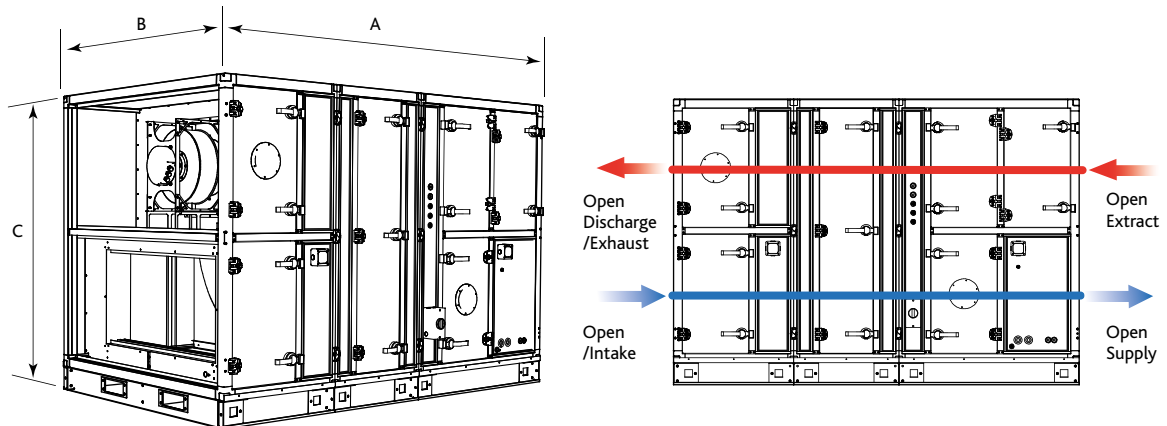

▲ Model shown is right hand.

Thermal Wheel					
Unit	Unit	A	A*	B	C
Thermal Wheel	07	2700	3150	1330	1492
Thermal Wheel	12	2700	3150	1530	1695
Thermal Wheel	17	2700	3150	1750	1900
Thermal Wheel	22	2800	3250	2030	2195
Thermal Wheel	32	3100	3650	2330	2498
Thermal Wheel	42	3100	3650	2730	2898

*Electric Heater is included.
Dimension 'A' is for LPHW or No heating.

BPS BOXER PACKAGED SOLUTIONS - VERTICAL UNIT - ANCILLARY OPTIONS (Based on right hand version)

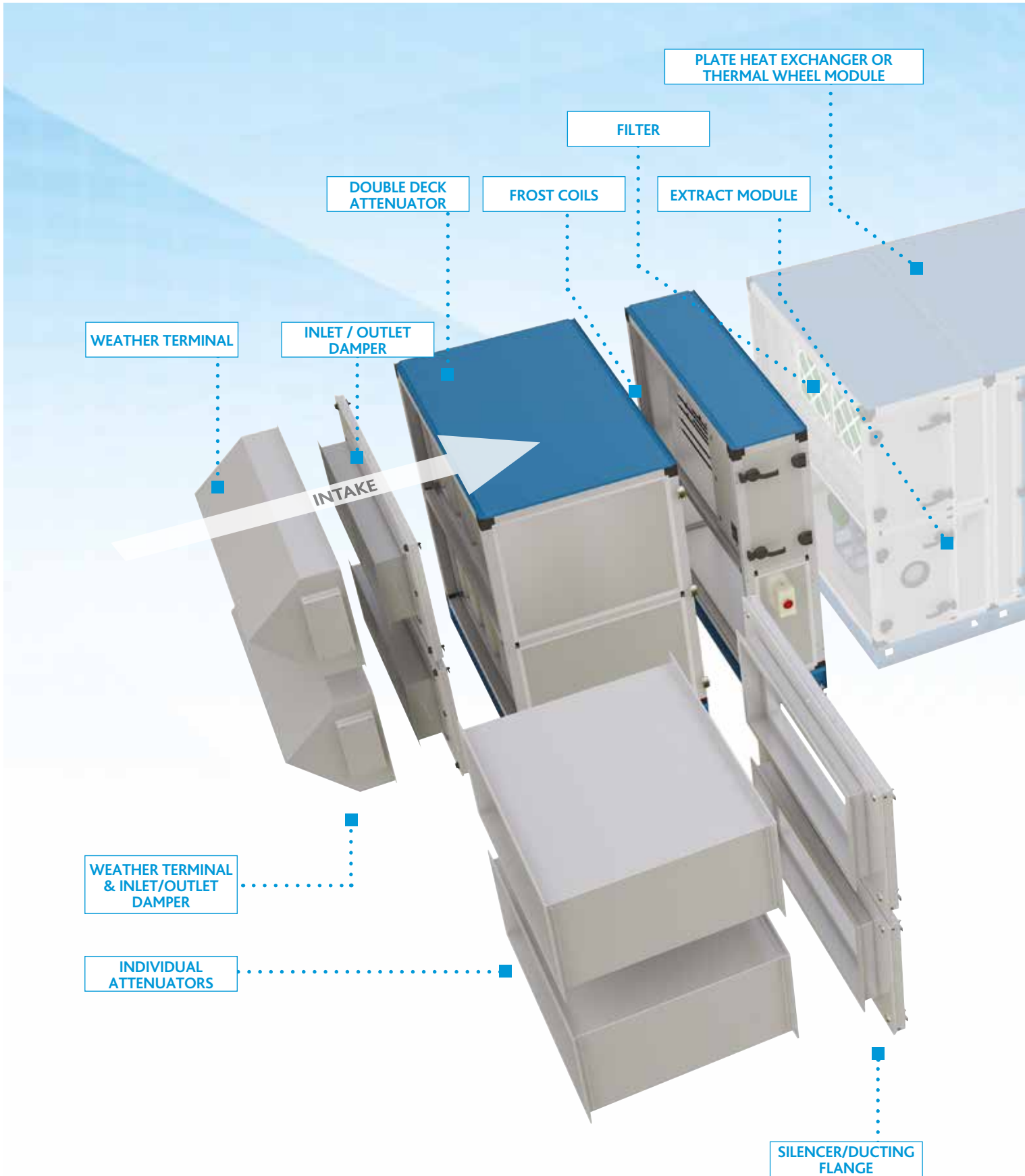

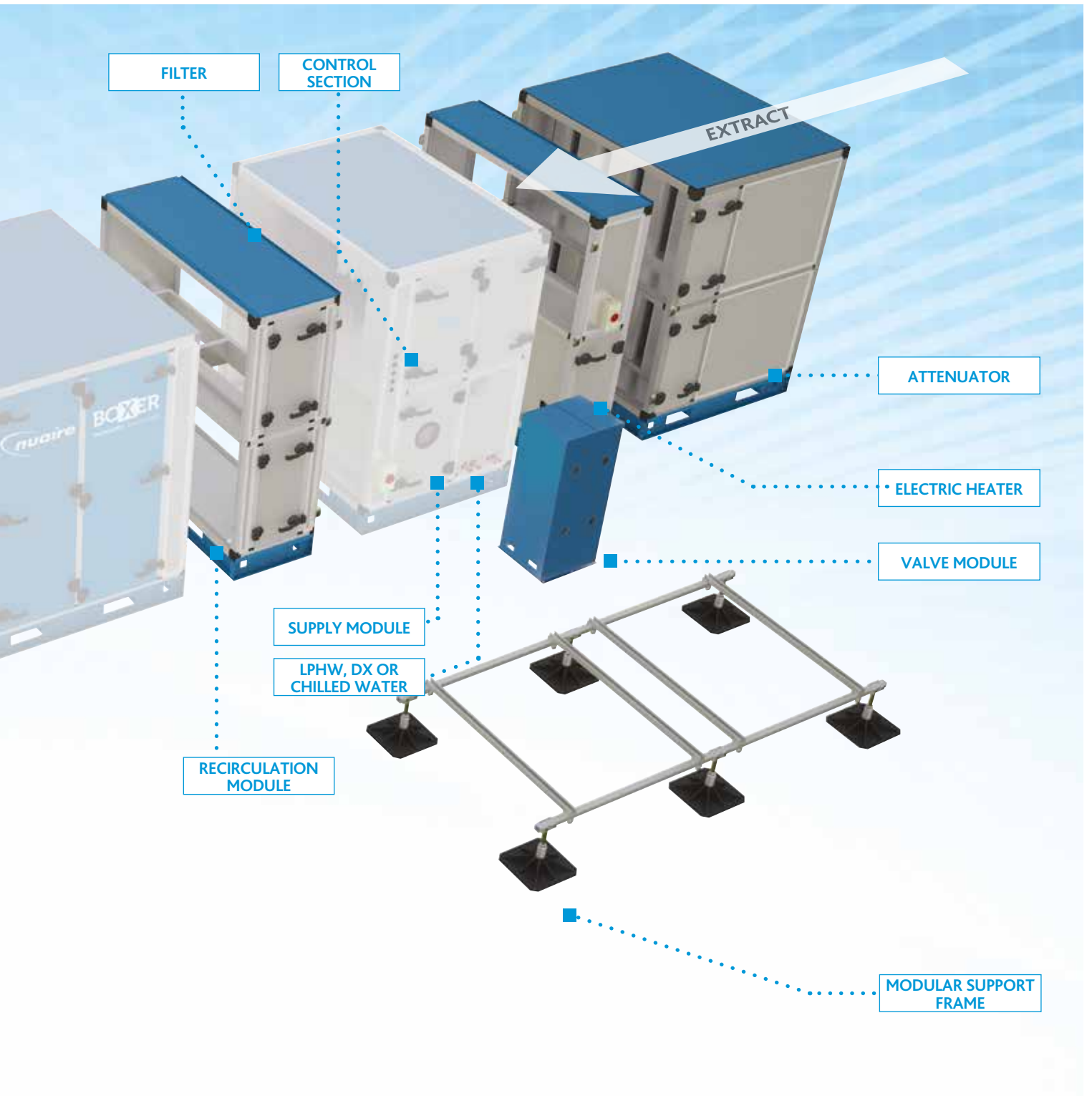

A full list of ancillaries, codes and dimensions for vertical units can be found on pages 62 - 67.

BPS BOXER PACKAGED SOLUTIONS - VERTICAL UNIT - ANCILLARY DETAILS & DIMENSIONS (mm)

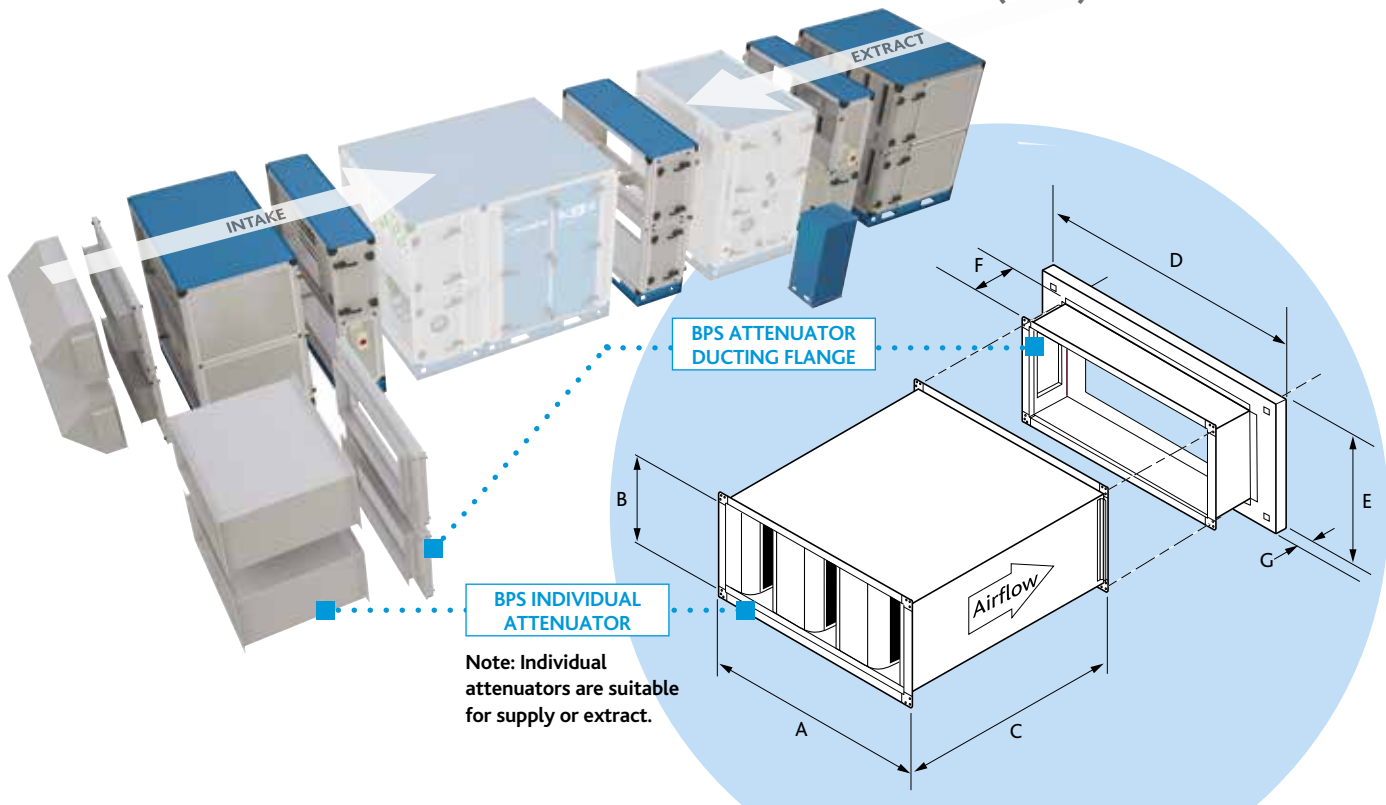

INDIVIDUAL BPS ATTENUATOR DIMENSIONS (mm), WEIGHTS (kg) & INSERTION LOSS (dB)															
Part Number	Description	A. Width	B. Height	C. Length	Weight (kg)	Vol (m ³ /s)	PL (Pa)	Attenuator Insertion loss							
								63	125	250	500	1k	2k	4k	8k
B07A/V-900	BPS size 07 attenuator 900mm length. (Use with attenuator flange, one per attenuator B07V/AF)	950	400	900	59	0.50	23	6	9	16	32	46	32	21	16
B07A/V-1200	BPS size 07 attenuator 1200mm length. (Use with attenuator flange, one per attenuator B07V/AF)	950	400	1200	75	0.50	24	3	5	11	22	21	14	11	8
B12A/V-900	BPS size 12 attenuator 900mm length. (Use with attenuator flange, one per attenuator B12V/AF)	1100	500	900	71	0.80	22	6	9	18	36	38	29	21	17
B12A/V-1200	BPS size 12 attenuator 1200mm length. (Use with attenuator flange one per attenuator B12V/AF)	1100	500	1200	90	0.90	24	8	11	22	44	48	38	25	19
B17A/V-900	BPS size 17 attenuator 900mm length. (Use with attenuator flange, one per attenuator B17V/AF)	1300	600	900	93	1.60	39	6	9	18	36	40	32	22	19
B17A/V-1200	BPS size 17 attenuator 1200mm length. (Use with attenuator flange, one per attenuator B17V/AF)	1300	600	1200	118	1.60	42	7	11	22	43	50	42	27	22
B22A/V-900	BPS size 22 attenuator 900mm length. (Use with attenuator flange one per attenuator B22V/AF)	1600	750	900	134	1.90	33	6	9	19	38	43	35	24	20
B22A/V-1200	BPS size 22 attenuator 1200mm length. (Us with attenuator flange, one per attenuator B22V/AF)	1600	750	1200	169	1.90	35	8	12	23	45	53	45	29	24
B32A/V-900	BPS size 32 attenuator 900mm length. (Use with attenuator flange, one per attenuator B32V/AF)	1900	850	900	159	3.00	39	6	10	19	38	41	33	23	19
B32A/V-1200	BPS size 32 attenuator 1200mm length. (Use with attenuator flange, one per attenuator B32V/AF)	1900	850	1200	200	3.00	42	8	12	23	46	52	42	27	22
B42A/V-900	BPS size 42 attenuator 900mm length. (Use with attenuator flange, one per attenuator B42V/AF)	2300	1050	900	217	3.80	28	6	10	19	38	41	33	23	19
B42A/V-1200	BPS size 42 attenuator 1200mm length. (Use with attenuator flange, one per attenuator B42V/AF)	2300	1050	1200	273	3.80	30	8	12	23	46	52	42	27	22

INDIVIDUAL BPS ATTENUATOR DUCTING FLANGE DIMENSIONS (mm), WEIGHTS (kg)							
Part Number	Description	D. Width	E. Height	F. Depth	G. Depth	Weight (kg)	
B12V/AF	BPS size 12 attenuator flange for vertical PHX or Thermal wheel. One required per attenuator	1412	682	204	53	20	Accommodates 1100 x 500mm internal 30mm Mez.
B17V/AF	BPS size 17 attenuator flange for vertical PHX or Thermal wheel. One required per attenuator	1632	792	204	53	24	Accommodates 1300 x 600mm internal 30mm Mez.
B22V/AF	BPS size 22 attenuator flange for vertical PHX or Thermal wheel. One required per attenuator	1912	932	204	53	29	Accommodates 1600 x 750mm internal 30mm Mez.
B32V/AF	BPS size 32 attenuator flange for vertical PHX or Thermal wheel. One required per attenuator	2212	1082	204	53	38	Accommodates 1900 x 850 mm internal 30mm Mez.
B42V/AF	BPS size 42 attenuator flange for vertical PHX or Thermal wheel. One required per attenuator	2612	1282	204	53	44	Accommodates 2300 x 1050mm internal 30mm Mez.

BPS BOXER PACKAGED SOLUTIONS - VERTICAL UNIT - ANCILLARY DETAILS & DIMENSIONS (mm)

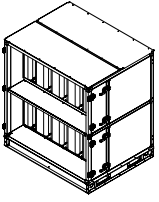
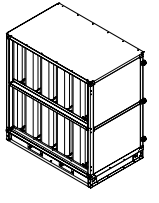
BPS BOXER PACKAGED AHUs - VERTICAL ANCILLARY DETAILS & DIMENSIONS (mm)															
BPS Ancillary	Description	Part Number	Part			Weight (kg)	Z Factor	Attenuator Insertion loss							
			Width	Height	Length			63	125	250	500	1k	2k	4k	8k
ATTENUATOR (SUPPLY/EXTRACT) 	BPS size **, Attenuator for supply/extract side. Right handed. For vertical PHX units.	B07AV//AR900-R	1330	1492	1350	313	22.45	5	7	15	31	34	25	18	14
		B12AV//AR900-R	1530	1695	1350	426	5.12	5	7	15	31	34	25	18	14
		B17AV//AR900-R	1750	1900	1350	540	6.53	6	9	18	37	42	34	23	19
		B22AV//AR900-R	2030	2195	1350	610	4.35	6	9	18	37	42	34	23	19
		B32AV//AR900-R	2330	2498	1350	597	0.85	5	7	15	31	34	25	18	14
		B42AV//AR900-R	2730	2898	1350	1540	0.89	6	9	18	37	42	34	23	19
	BPS size **, Attenuator for supply/extract side. Left handed. For vertical PHX units.	B07AV//AR900-L	1330	1492	1350	313	22.45	5	7	15	31	34	25	18	14
		B12AV//AR900-L	1530	1695	1350	426	5.12	5	7	15	31	34	25	18	14
		B17AV//AR900-L	1750	1900	1350	540	6.53	6	9	18	37	42	34	23	19
		B22AV//AR900-L	2030	2195	1350	610	4.35	6	9	18	37	42	34	23	19
		B32AV//AR900-L	2330	2498	1350	597	0.85	5	7	15	31	34	25	18	14
		B42AV//AR900-L	2730	2898	1350	1540	0.89	6	9	18	37	42	34	23	19
	BPS size **, Attenuator for supply/extract side. Right handed. For vertical Thermal wheel units.	B07AT//AR900-R	1330	1492	1350	313	22.45	5	7	15	31	34	25	18	14
		B12AT//AR900-R	1530	1695	1350	426	5.12	5	7	15	31	34	25	18	14
		B17AT//AR900-R	1750	1900	1350	540	6.53	6	9	18	37	42	34	23	19
		B22AT//AR900-R	2030	2195	1350	610	4.35	6	9	18	37	42	34	23	19
		B32AT//AR900-R	2330	2498	1350	597	0.85	5	7	15	31	34	25	18	14
		B42AT//AR900-R	2730	2898	1350	1540	0.89	6	9	18	37	42	34	23	19
	BPS size **, Attenuator for supply/extract side. Left handed. For vertical Thermal wheel units.	B07AT//AR900-L	1330	1492	1350	313	22.45	5	7	15	31	34	25	18	14
		B12AT//AR900-L	1530	1695	1350	426	5.12	5	7	15	31	34	25	18	14
		B17AT//AR900-L	1750	1900	1350	540	6.53	6	9	18	37	42	34	23	19
		B22AT//AR900-L	2030	2195	1350	610	4.35	6	9	18	37	42	34	23	19
		B32AT//AR900-L	2330	2498	1350	597	0.85	5	7	15	31	34	25	18	14
		B42AT//AR900-L	2730	2898	1350	1540	0.89	6	9	18	37	42	34	23	19
ATTENUATOR (INTAKE/EXHAUST) 	BPS size **, Attenuator for Intake/exhaust side. Right handed. For vertical PHX units.	B07AV//AA900-R	1330	1492	1090	273	22.45	5	7	15	31	34	25	18	14
		B12AV//AA900-R	1530	1695	1090	377	5.12	5	7	15	31	34	25	18	14
		B17AV//AA900-R	1750	1900	1090	470	6.53	6	9	18	37	42	34	23	19
		B22AV//AA900-R	2030	2195	1090	525	4.35	6	9	18	37	42	34	23	19
		B32AV//AA900-R	2330	2498	1090	526	0.85	5	7	15	31	34	25	18	14
		B42AV//AA900-R	2730	2898	1090	1460	0.89	6	9	18	37	42	34	23	19
	BPS size **, Attenuator for Intake/exhaust side. Left handed. For vertical PHX units.	B07AV//AA900-L	1330	1492	1090	273	22.45	5	7	15	31	34	25	18	14
		B12AV//AA900-L	1530	1695	1090	377	5.12	5	7	15	31	34	25	18	14
		B17AV//AA900-L	1750	1900	1090	470	6.53	6	9	18	37	42	34	23	19
		B22AV//AA900-L	2030	2195	1090	525	4.35	6	9	18	37	42	34	23	19
		B32AV//AA900-L	2330	2498	1090	526	0.85	5	7	15	31	34	25	18	14
		B42AV//AA900-L	2730	2898	1090	1460	0.89	6	9	18	37	42	34	23	19
	BPS size **, Attenuator for Intake/exhaust side. Right handed. For vertical Thermal wheel units.	B07AT//AA900-R	1330	1492	1090	273	22.45	5	7	15	31	34	25	18	14
		B12AT//AA900-R	1530	1695	1090	377	5.12	5	7	15	31	34	25	18	14
		B17AT//AA900-R	1750	1900	1090	470	6.53	6	9	18	37	42	34	23	19
		B22AT//AA900-R	2030	2195	1090	525	4.35	6	9	18	37	42	34	23	19
		B32AT//AA900-R	2330	2498	1090	526	0.85	5	7	15	31	34	25	18	14
		B42AT//AA900-R	2730	2898	1090	1460	0.89	6	9	18	37	42	34	23	19
	BPS size **, Attenuator for Intake/exhaust side. Left handed. For vertical Thermal wheel units.	B07AT//AA900-L	1330	1492	1090	273	22.45	5	7	15	31	34	25	18	14
		B12AT//AA900-L	1530	1695	1090	377	5.12	5	7	15	31	34	25	18	14
		B17AT//AA900-L	1750	1900	1090	470	6.53	6	9	18	37	42	34	23	19
		B22AT//AA900-L	2030	2195	1090	525	4.35	6	9	18	37	42	34	23	19
		B32AT//AA900-L	2330	2498	1090	526	0.85	5	7	15	31	34	25	18	14
		B42AT//AA900-L	2730	2898	1090	1460	0.89	6	9	18	37	42	34	23	19

** Insert either 07, 12, 17, 22, 32 or 42 for the relevant BPS unit.

BPS BOXER PACKAGED SOLUTIONS - VERTICAL UNIT - ANCILLARY DETAILS & DIMENSIONS (mm)

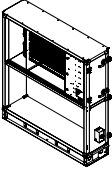
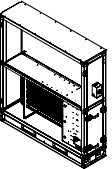
BPS BOXER PACKAGED AHUS - VERTICAL ANCILLARY DETAILS & DIMENSIONS (mm)								
BPS Ancillary	Description	Part Number	Width	Height	Length	Weight (kg)	Z Factor	
FROST COIL (ELECTRIC) 	BPS size **, Frost coil electric.	12kW.	B07AV/FE-R	1330	1492	450	130	12.24
		24kW.	B12AV/FE-R	1530	1695	450	153	3.84
	Right handed.	36kW.	B17AV/FE-R	1750	1900	450	160	0.816
		36kW.	B22AV/FE-R	2030	2195	450	195	0.79
	For vertical PHX units.	60kW.	B32AV/FE-R	2330	2498	550	368	1.23
		72kW.	B42AV/FE-R	2730	2898	550	415	0.28
	BPS size **, Frost coil electric.	12kW.	B07AV/FE-L	1330	1492	450	130	12.24
		24kW.	B12AV/FE-L	1530	1695	450	153	3.84
	Left handed.	36kW.	B17AV/FE-L	1750	1900	450	160	0.816
		36kW.	B22AV/FE-L	2030	2195	450	195	0.79
	For vertical PHX units.	60kW.	B32AV/FE-L	2330	2498	550	368	1.23
		72kW.	B42AV/FE-L	2730	2898	550	415	0.28
	BPS size **, Frost coil electric.	12kW.	B07AT/FE-R	1330	1492	450	130	12.24
		24kW.	B12AT/FE-R	1530	1695	450	153	3.84
Right handed.	36kW.	B17AT/FE-R	1750	1900	450	160	0.816	
	36kW.	B22AT/FE-R	2030	2195	450	195	0.79	
For vertical Thermal wheel units.	60kW.	B32AT/FE-R	2330	2498	550	368	1.23	
	72kW.	B42AT/FE-R	2730	2898	550	415	0.28	
BPS size **, Frost coil electric.	12kW.	B07AT/FE-L	1330	1492	450	130	12.24	
	24kW.	B12AT/FE-L	1530	1695	450	153	3.84	
Left handed.	36kW.	B17AT/FE-L	1750	1900	450	160	0.816	
	36kW.	B22AT/FE-L	2030	2195	450	195	0.79	
For vertical Thermal wheel units.	60kW.	B32AT/FE-L	2330	2498	550	368	1.23	
	72kW.	B42AT/FE-L	2730	2898	550	415	0.28	
FROST COIL (LPHW) 	BPS size **, Frost coil LPHW		B07AV/FL-R	1330	1492	450	139	28.57
			B12AV/FL-R	1530	1695	450	160	8.96
	Right handed.		B17AV/FL-R	1750	1900	450	160	2.122
			B22AV/FL-R	2030	2195	450	195	2.17
	For vertical PHX units.		B32AV/FL-R	2330	2498	550	297	1.704
			B42AV/FL-R	2730	2898	550	355	0.78
	BPS size **, Frost coil LPHW,		B07AV/FL-L	1330	1492	450	139	28.57
			B12AV/FL-L	1530	1695	450	160	8.96
	Left handed.		B17AV/FL-L	1750	1900	450	160	2.122
			B22AV/FL-L	2030	2195	450	195	2.17
	For vertical PHX units.		B32AV/FL-L	2330	2498	550	297	1.704
			B42AV/FL-L	2730	2898	550	355	0.78
	BPS size **, Frost coil LPHW,		B07AT/FL-R	1330	1492	450	139	28.57
			B12AT/FL-R	1530	1695	450	160	8.96
Right handed.		B17AT/FL-R	1750	1900	450	160	2.122	
		B22AT/FL-R	2030	2195	450	195	2.17	
For vertical Thermal wheel units.		B32AT/FL-R	2330	2498	550	297	1.704	
		B42AT/FL-R	2730	2898	550	355	0.78	
BPS size **, Frost coil LPHW,		B07AT/FL-L	1330	1492	450	139	28.57	
		B12AT/FL-L	1530	1695	450	160	8.96	
Left handed.		B17AT/FL-L	1750	1900	450	160	2.122	
		B22AT/FL-L	2030	2195	450	195	2.17	
For vertical Thermal wheel units.		B32AT/FL-L	2330	2498	550	297	1.704	
		B42AT/FL-L	2730	2898	550	355	0.78	

** Insert either 07, 12, 17, 22, 32 or 42 for the relevant BPS unit.

BPS BOXER PACKAGED SOLUTIONS - VERTICAL UNIT - ANCILLARY DETAILS

FROST COIL DATA @ 100% SPEED

Part Number	Airflow (m ³ /s)	Water parameters		Ethyl Glycol %	Air Condition Dry bulb (°C)		Coil Duty (kW)	Water flow (l/s)	Coil Δp (kPa)
		Inlet temp. (°C)	Outlet temp. (°C)		Entering Coil	After Coil			
B7AV/FL-*	1	82	71	0	-10	5	20.16	0.449	29.3
	1	80	60	0	-10	5	20.16	0.246	10
	1	60	40	0	-10	5	20.16	0.244	10
B12AV/FL-*	1.7	82	71	0	-10	5	34.27	0.763	12.1
	1.7	80	60	0	-10	5	34.27	0.418	3.8
	1.7	60	40	0	-7	5	27.17	0.329	2.4
B17AV/FL-*	2	82	71	0	-10	5	40.3	0.897	23.6
	2	80	60	0	-10	5	40.3	0.492	7.6
	2	60	40	0	-9.6	5	39.4	0.478	7.4
B22AV/FL-*	2.7	82	71	0	-10	5	54.4	1.211	39.6
	2.7	80	60	0	-10	5	54.4	0.664	12.6
	2.7	60	40	0	-10	5	54.4	0.66	12.8
B32AV/FL-*	4.1	82	71	0	-10	5	82.7	1.839	22.9
	4.1	80	60	0	-10	5	82.7	1.009	7.3
	4.1	60	40	0	-9.3	5	78.5	0.952	6.8
B42AV/FL-*	5.4	82	71	0	-10	5	108.9	2.423	49
	5.4	80	60	0	-10	5	108.9	1.329	16.4
	5.4	60	40	0	-10	5	108.9	1.32	17.4



FROST COIL DATA @ 75% SPEED

B7AV/FL-*	0.75	82	71	0	-10	5	15.12	0.336	17.9
	0.75	80	60	0	-10	5	15.12	0.185	6
	0.75	60	40	0	-10	5	15.12	0.183	6.2
B12AV/FL-*	1.275	82	71	0	-10	5	25.7	0.572	7
	1.275	80	60	0	-10	5	25.7	0.314	2.2
	1.275	60	40	0	-8	5	22.1	0.268	1.7
B17AV/FL-*	1.5	82	71	0	-10	5	30.2	0.673	13.6
	1.5	80	60	0	-10	5	30.2	0.369	4.4
	1.5	60	40	0	-10	5	30.2	0.367	4.5
B22AV/FL-*	2.025	82	71	0	-10	5	40.8	0.908	22.7
	2.025	80	60	0	-10	5	40.8	0.498	7.4
	2.025	60	40	0	-10	5	40.8	0.495	7.5
B32AV/FL-*	3.075	82	71	0	-10	5	62	1.38	13.2
	3.075	80	60	0	-10	5	62	0.757	4.3
	3.075	60	40	0	-10	5	62	0.752	4.3
B42AV/FL-*	4.05	82	71	0	-10	5	81.6	1.817	29.3
	4.05	80	60	0	-10	5	81.6	0.996	9.8
	4.05	60	40	0	-10	5	81.6	0.99	10.1

FROST COIL DATA @ 50% SPEED

B7AV/FL-*	0.5	82	71	0	-10	5	10.08	0.224	8.4
	0.5	80	60	0	-10	5	10.08	0.123	2.9
	0.5	60	40	0	-10	5	10.08	0.122	3
B12AV/FL-*	0.85	82	71	0	-10	5	17.14	0.381	3.2
	0.85	80	60	0	-10	5	17.14	0.209	1
	0.85	60	40	0	-7.5	5	14.14	0.171	0.7
B17AV/FL-*	1	82	71	0	-10	5	20.2	0.449	6.3
	1	80	60	0	-10	5	20.2	0.246	2.1
	1	60	40	0	-10	5	20.2	0.244	2.1
B22AV/FL-*	1.35	82	71	0	-10	5	27.2	0.606	10.6
	1.35	80	60	0	-10	5	27.2	0.332	3.4
	1.35	60	40	0	-10	5	27.2	0.33	3.5
B32AV/FL-*	2.05	82	71	0	-10	5	41.3	0.92	6.1
	2.05	80	60	0	-10	5	41.3	0.504	2
	2.05	60	40	0	-10	5	41.3	0.501	2
B42AV/FL-*	2.7	82	71	0	-10	5	54.4	1.211	13.8
	2.7	80	60	0	-10	5	54.4	0.664	4.6
	2.7	60	40	0	-10	5	54.4	0.66	4.8

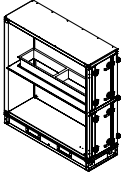
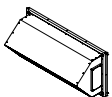
BPS BOXER PACKAGED SOLUTIONS - VERTICAL UNIT - ANCILLARY PART NUMBERS & DIMENSIONS (mm)

BPS BOXER PACKAGED AHUS - VERTICAL ANCILLARY DETAILS & DIMENSIONS (mm)							
BPS Ancillary	Description	Part Number	Width	Height	Length	Weight (kg)	Z Factor
RE-CIRCULATION MODULE 	BPS size **, Recirculation module. Right handed. For vertical PHX units.	B07AV/RM-R	1330	1492	600	134	
		B12AV/RM-R	1530	1695	600	150	
		B17AV/RM-R	1750	1900	600	150	
		B22AV/RM-R	2030	2195	600	190	
		B32AV/RM-R	2330	2498	600	237	
		B42AV/RM-R	2730	2898	600	280	
	BPS size **, Recirculation module. Left handed. For vertical PHX units.	B07AV/RM-L	1330	1492	600	134	
		B12AV/RM-L	1530	1695	600	150	
		B17AV/RM-L	1750	1900	600	150	
		B22AV/RM-L	2030	2195	600	190	
		B32AV/RM-L	2330	2498	600	237	
		B42AV/RM-L	2730	2898	600	280	
	BPS size **, Recirculation module. Right handed. For vertical Thermal wheel units.	B07AT/RM-R	1330	1492	600	134	
		B12AT/RM-R	1530	1695	600	150	
		B17AT/RM-R	1750	1900	600	150	
		B22AT/RM-R	2030	2195	600	190	
		B32AT/RM-R	2330	2498	600	237	
		B42AT/RM-R	2730	2898	600	280	
	BPS size **, Recirculation module. Left handed. For vertical Thermal wheel units.	B07AT/RM-L	1330	1492	600	134	
		B12AT/RM-L	1530	1695	600	150	
B17AT/RM-L		1750	1900	600	150		
B22AT/RM-L		2030	2195	600	190		
B32AT/RM-L		2330	2498	600	237		
B42AT/RM-L		2730	2898	600	280		
ROOF TERMINAL 	BPS size **, Roof terminal. For vertical PHX units.	B07AV/RT	1416	682	515	22	48.97
		B12AV/RT	1416	682	515	29	15.36
		B17AV/RT	1640	800	600	34	2.94
		B22AV/RT	1915	935	650	45	2.77
		B32AV/RT	2210	1081	725	62	1.51
		B42AV/RT	2610	1280	820	77	0.78
	BPS size **, Roof terminal. For vertical Thermal wheel units.	B07AT/RT	1416	682	515	22	48.97
		B12AT/RT	1416	682	515	29	15.36
		B17AT/RT	1640	800	600	34	2.94
		B22AT/RT	1915	935	650	45	2.77
		B32AT/RT	2210	1081	725	62	1.51
		B42AT/RT	2610	1280	820	77	0.78
INLET/OUTLET DAMPER 	BPS size **, Inlet/outlet dampers. Suitable for left and right handed vertical PHX units.	B07AV/D	1416	682	215	18	22.44
		B12AV/D	1416	682	215	24	7.04
		B17AV/D	1640	800	210	40	1.96
		B22AV/D	1915	935	220	43	1.58
		B32AV/D	2210	1081	220	63	0.85
		B42AV/D	2610	1280	220	98	0.28
	BPS size **, Inlet/outlet dampers. Suitable for left and right handed vertical Thermal wheel units.	B07AT/D	1416	682	215	18	22.44
		B12AT/D	1416	682	215	24	7.04
		B17AT/D	1640	800	210	40	1.96
		B22AT/D	1915	935	220	43	1.58
		B32AT/D	2210	1081	220	63	0.85
		B42AT/D	2610	1280	220	98	0.28

** Insert either 07, 12, 17, 22, 32 or 42 for the relevant BPS unit.

BPS BOXER PACKAGED SOLUTIONS - VERTICAL UNIT - ANCILLARY PART NUMBERS & DIMENSIONS (mm)

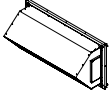
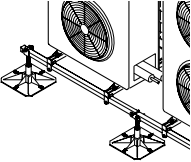
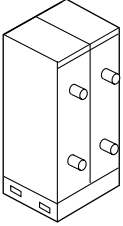
BPS BOXER PACKAGED AHUS - VERTICAL ANCILLARY DETAILS & DIMENSIONS (mm)							
BPS Ancillary	Description	Part Number	Width	Height	Length	Weight (kg)	Z Factor
ROOF TERMINAL & INLET/OUTLET DAMPER 	BPS size **, Roof terminal & damper. Right handed. For vertical PHX units.	B07AV/RTD-R	1416	682	515	30	71.42
		B12AV/RTD-R	1416	682	515	40	15.36
		B17AV/RTD-R	1750	1900	600	150	4.9
		B22AV/RTD-R	2030	2195	600	190	2.77
		B32AV/RTD-R	2210	1081	725	94	2.55
		B42AV/RTD-R	2610	1280	820	140	0.78
	BPS size **, Roof terminal & damper. Left handed. For vertical PHX units.	B07AV/RTD-L	1416	682	515	30	71.42
		B12AV/RTD-L	1416	682	515	40	15.36
		B17AV/RTD-L	1750	1900	600	150	4.9
		B22AV/RTD-L	2030	2195	600	190	2.77
		B32AV/RTD-L	2210	1081	725	94	2.55
		B42AV/RTD-L	2610	1280	820	140	0.78
	BPS size **, Roof terminal & damper. Right handed. For vertical Thermal wheel units.	B07AT/RTD-R	1416	682	515	30	71.42
		B12AT/RTD-R	1416	682	515	40	15.36
		B17AT/RTD-R	1750	1900	600	150	4.9
		B22AT/RTD-R	2030	2195	600	190	2.77
		B32AT/RTD-R	2210	1081	725	94	2.55
		B42AT/RTD-R	2610	1280	820	140	0.78
	BPS size **, Roof terminal & damper. Left handed. For vertical Thermal wheel units.	B07AT/RTD-L	1416	682	515	30	71.42
		B12AT/RTD-L	1416	682	515	40	15.36
B17AT/RTD-L		1750	1900	600	150	4.9	
B22AT/RTD-L		2030	2195	600	190	2.77	
B32AT/RTD-L		2210	1081	725	94	2.55	
B42AT/RTD-L		2610	1280	820	140	0.78	
MODULAR SUPPORT FRAME 	BPS size **, Modular support frame	Contact Nuaire for details					
VALVE MODULE 	BPS size **, Valve Module in protective enclosure with LPHW. With Connect or Adapt Trend Control. Includes PICV & Actuator.	B07A/VM-L	450	1050	450	33	
		B12A/VM-L	450	1050	450	36.3	
		B17A/VM-L	450	1050	450	37	
		B22A/VM-L	450	1050	450	46.5	
		B32A/VM-L	450	1050	450	46.5	
		B42A/VM-L	450	1050	450	46.5	
	BPS size **, Valve Module in protective enclosure with LPHW & Chilled Water. With Connect or Adapt Trend Control. Includes PICV & Actuator.	B07A/VM-LC	450	1050	450	41	
		B12A/VM-LC	450	1050	450	44.3	
		B17A/VM-LC	450	1050	450	48.3	
		B22A/VM-LC	450	1050	450	61.5	
		B32A/VM-LC	450	1050	450	68	
		B42A/VM-LC	450	1050	450	68	
	BPS size **, Valve Module in protective enclosure with Chilled Water. With Connect or Adapt Trend Control. Includes PICV & Actuator.	B07A/VM-C	450	1050	450	33	
		B12A/VM-C	450	1050	450	33	
		B17A/VM-C	450	1050	450	36.3	
		B22A/VM-C	450	1050	450	40	
		B32A/VM-C	450	1050	450	46.5	
		B42A/VM-C	450	1050	450	46.5	
	Note: For 3 port valves, contact Nuaire. BPS size **, Valve Module in protective enclosure with LPHW. With Classic Control. Includes PICV & Actuator.	B07A/VM-L-ES	450	1050	450	33	
		B12A/VM-L-ES	450	1050	450	36.3	
B17A/VM-L-ES		450	1050	450	37		
B22A/VM-L-ES		450	1050	450	46.5		
B32A/VM-L-ES		450	1050	450	46.5		
B42A/VM-L-ES		450	1050	450	46.5		

** Insert either 07, 12, 17, 22, 32 or 42 for the relevant BPS unit.

BPS BOXER PACKAGED SOLUTIONS - FULLY INTEGRATED REVERSE CYCLE DX WITH CONTROL PAC

BPS UNITS ARE AVAILABLE WITH MITSUBISHI MR SLIM CONDENSERS KEY FEATURES:

Condensing units are supplied with base frames. (for use with Ecosmart Connect or Adapt control)

Built in Ecosmart Connect or Adapt control. (Below with PAC controller)

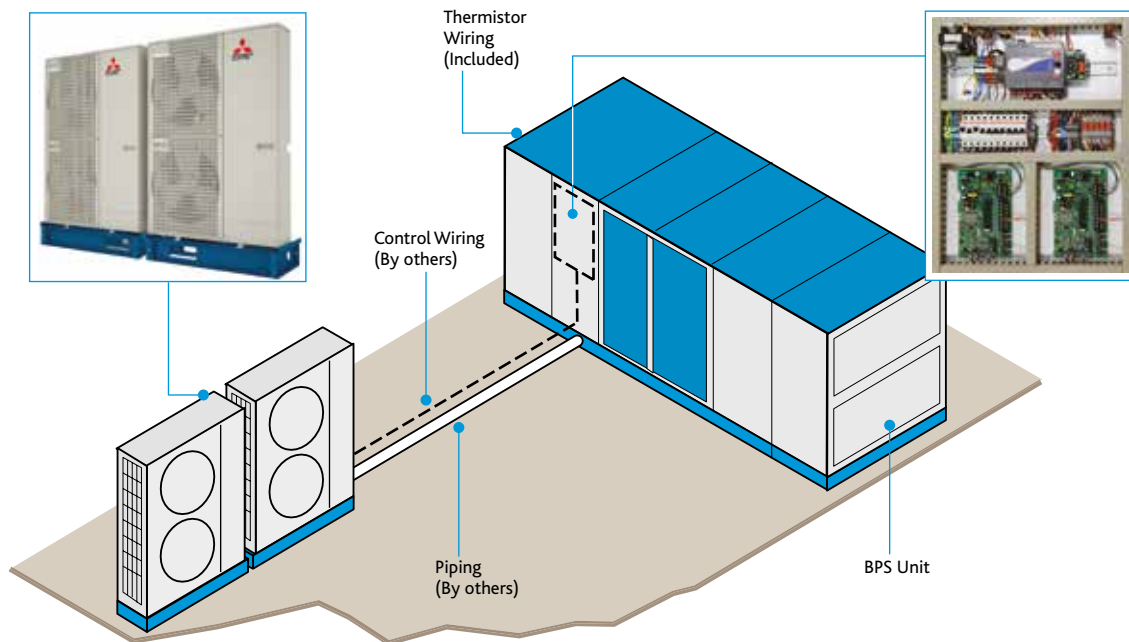

- Simpler installation due to BPS unit with Reverse cycle DX coil and Mr Slim condensers being a single source of heating and cooling.
- BEMS external monitoring and control can be achieved through direct Modbus, digital switches or analogue input.
- Anti-cycling measures incorporated into the design to extend the life of the outdoor units.
- Mr Slim Condensers are supplied loose for integration on site by others.
- Condensers are only available with Ecosmart Connect or Ecosmart Adapt controlled BPS units. PAC controllers are supplied built into unit.

- Mr Slim Condensers are supplied with a 3 year Warranty (The 3 year warranty of the Mitsubishi Electric Equipment as supplied by Nuair will be held by Nuair & Kooltech Ltd).
- The installation should be carried out by either a Mitsubishi Accredited installer, business solution partner or Diamond partner. If the above is not adhered to, the stated warranty will be void and all equipment will only have a 12 month defect warranty subject to terms and conditions. For details contact Nuair.
- BPS with fully integrated reverse cycle DX and PAC control provides a complete system.

DIMENSIONS (mm) CONDENSER/FRAME

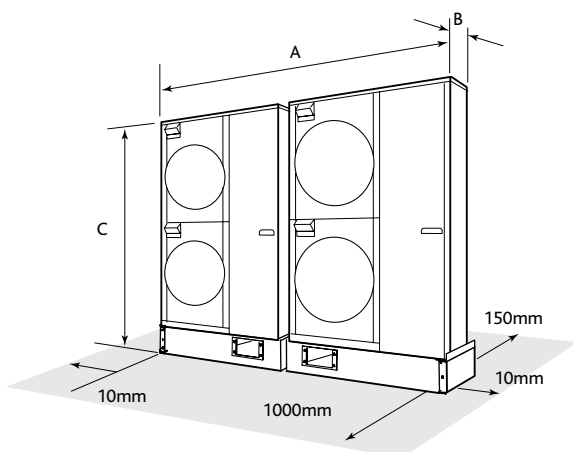

Condenser Unit complete with support frame					
Code	BPS unit size	*A	B	C	Qty
BPS-CU-MIT-14	07	1000	420	1500	1
BPS-CU-MIT-20	12	1000	420	1500	1
BPS-CU-MIT-14	17	2000	420	1500	2
BPS-CU-MIT-20	22	2000	420	1500	2
BPS-CU-MIT-20	32	3000	420	1500	3
BPS-CU-MIT-25	42	3000	420	1500	3
BPS-CU-MIT-14	05H	1000	420	1500	1
BPS-CU-MIT-14	10H	1000	420	1500	1
BPS-CU-MIT-20	15H	1000	420	1500	1
BPS-CU-MIT-25	20H	3000	420	1500	1

*DIM 'A' refers overall width for either 1, 2 or 3 condensers. Contact Nuair for full technical details and detailed dimensions of condensing units.

Note: Condensers are supplied loose for integration on site by others.

*The 3 year warranty of the Mitsubishi Electric Equipment as supplied by Nuair will be held by Nuair & Kooltech Ltd. The installation should be carried out by either a Mitsubishi Accredited installer, business solution partner or Diamond partner. If the above is not adhered to, the stated warranty will be void and all equipment will only have a 12 month defect warranty subject to terms and conditions. For technical details contact Nuair.

BPS BOXER PACKAGED SOLUTIONS - FULLY INTEGRATED REVERSE CYCLE DX WITH CONTROL PAC

SERVICE REF.			BPS-CU-MIT-20		BPS-CU-MIT-25		
Mode			Cooling	Heating	Cooling	Heating	
OUTDOOR UNIT	Power supply (phase cycle voltage)		3 phase 50Hz, 400V				
	Running current	A	9.47	9.88	11.0	12.0	
	Max. current	A	19		21		
	External finish		Munsell 3Y 7.8/1.1				
	Refrigerant control		Linear Expansion Valve				
	Compressor		Hermetic				
	Model		YHA: ANB52FFJMT or ANB52FFPMT YHA3!R1 R2 R3\ ANB52FFPMT				
	Motor output	kW	4.7		5.5		
	Starter type		Line start				
	Protection devices		HP switch Discharge thermo				
	Crankcase heater		W				
	Heat exchanger		Plate fin coil				
	Fan	Fan(drive) x No.		Propeller fan x 2			
		Fan motor output	kW	0.150 + 0.150			
		Airflow	m³/min(l/s)	130(2170) 0			
	Defrost method		Reverse cycle				
	Noise level	Cooling	dB	59		59	
		Heating	dB	59		59	
Dimensions	W	mm(in.)	950(37-3/8)				
	D	mm(in.)	330 + 30(13+1-3/16)				
	H	mm(in.)	1,350(53-1/8)				
Weight		kg(lbs)	126(278)		YHA, YHA3R3: 133(294)/ YHA3(R1,R2): 135(298)		
Refrigerant		R410A					
Charge	kg(lbs)		5.8(12.8)		7.1(15.7)		
	Oil (Model)		L		2.30(FV50S)		
Pipe size O.D.	Liquid	mm(in.)	9.52(3/8)		12.7(1/2)		
	Gas	mm(in.)	25.4(1)		25.4(1)		
Connection method	Indoor side		Flared				
	Outdoor side		Flared & Brazing				
Between the indoor & outdoor unit	Height difference		Max. 30m				
	Piping length		Max. 70m				

SERVICE REF.			BPS-CU-MIT-14				
Mode			Cooling	Heating			
OUTDOOR UNIT	Power supply (phase cycle voltage)		Single phase 50Hz, 230V				
	Running current	A	22.48	21.31			
	Max. current	A	29.5				
	External finish		Munsell 3Y 7.8/1.1 (VHA3R1)				
	Refrigerant control		Linear Expansion Valve				
	Compressor		Hermetic				
	Model		TNB306FPGM				
	Motor output	kW	3.9				
	Starter type		Inverter				
	Protection devices		HP switch Discharge thermo				
	Crankcase heater		W				
	Heat exchanger		Plate fin coil				
	Fan	Fan(drive) x No.		Propeller fan x 2			
		Fan motor output	kW	0.060 + 0.060			
		Airflow	m³/min(l/s)	100(3,530)			
	Defrost method		Reverse cycle				
	Noise level	Cooling	dB	52			
		Heating	dB	56			
Dimensions	W	mm(in.)	950(37-3/8)				
	D	mm(in.)	330 + 30(13+1-3/16)				
	H	mm(in.)	1,350(53-1/8)				
Weight		kg(lbs)	99(218)				
Refrigerant		R32					
Charge	kg(lbs)		4.5(9.9)				
	Oil (Model)		L		0.87(FV50S)		
Pipe size O.D.	Liquid	mm(in.)	9.52(3/8)				
	Gas	mm(in.)	25.4(1)				
Connection method	Indoor side		Flared				
	Outdoor side		Flared				
Between the indoor & outdoor unit	Height difference		Max. 30m				
	Piping length		Max. 50m				

BPS BOXER PACKAGED SOLUTIONS - CONSULTANTS SPECIFICATION

OPERATION

The packaged supply and extract unit shall be manufactured from Aluzinc corrosion resistant steel, with 50mm double skinned panels and anodized aluminium frame. All external fittings and fixings shall be stainless steel, aluminium or non-metallic. All panels and frames will be of a totally thermally-broken design, complying with the following specification in accordance with BS EN 1886: Mechanical strength, D1; Leakage class, L1; Thermal transmittance, T2; Thermal bridging, TB1. Panels and frames will be sealed without the use of silicon, mastic or other liquid gasket.

The unit shall include the following items: -

Plate HX:

A high efficiency, ERP compliant heat exchanger with automatic bypass and power saving partial bypass, complete with a condensate tray and pump offering 20m of head pressure. G4 pre-filter and F7 main supply filters shall be fitted with a single M5 bank present on the extract side. Slides for alternative panel and bag options shall be present and pressure drop monitoring for maintenance notification will be included.

Thermal Wheel HX:

A high efficiency, ERP compliant heat exchanger with automatic bypass, complete with a condensate tray and pump (where cooling is fitted) offering 20m of head pressure. G4 pre-filter and F7 main supply filters shall be fitted with a single M5 bank present on the extract side. Slides for alternative panel and bag options shall be present and pressure drop monitoring for maintenance notification will be included.

Performance optimised backward curved impellers and IP54 EC motors shall be used to provide low specific fan powers and stepless speed control without tonal noise generation. Fan pressure transducers shall be fitted (ES Connect & Adapt only) for constant pressure/flow control and energy monitoring. Internal lighting and inspection portholes shall be present on all fan modules.

All hinged access panels shall be lockable and removable (with a common key for all) allowing full maintenance access from the side. The unit has left (and right option) hand arrangement in direction of supply air flow.

- A LPHW heater battery shall be fitted (on LPHW units).
- An electric heater module shall be present (on Electric heater units), complete with power controller to allow output modulation from the unit control.
- A fail-safe auto-reset safety device shall be present.
- A chilled water cooling coil shall be fitted (on chilled water units).

A reverse cycle DX coil shall be fitted (on DX-R units), with 5 psi oxygen free

nitrogen (OFN) holding charge. The coil is sized to suit the accompanying PUHZ-P140 Mitsubishi condensing unit(s) (including baseframes) with preconfigured Mitsubishi PAC control interface(s) and sensors pre-fitted to the main unit.

Structural baseframes shall be fitted, powder coated with covered forklift slots and 50mm square lifting bar holes for site manoeuvrability. Three axis alignment clamps shall be fitted externally.

All modules and ancillaries shall be individual weatherproofed with nanotech hydrophobic roofing, providing unparalleled corrosion resistance and aesthetic longevity.

An IP66/67 lockable isolator shall be present for power connection on main and electric heater modules. Sealing grommets will be present for control cable access to the unit internals without the need for drilling on site. Module electrical interconnection shall be made using pre-fitted plug and socket arrangements.

Modules shall be provided with identification labelling to aid assembly and QR coded badges to simplify document retrieval via portable devices.

Autodesk REVIT files shall be provided for Building Information Modelling and all units shall be based on performance testing carried out within an AMCA certified test laboratory.

CODE DESCRIPTION

B 8 17 V / L R / CO - L
| | | | | | | |
1 2 3 4 5 6 7 8

1. BOXER Package Solution Range
2. ERP year:
8 = 2018
3. Horizontal Unit size: 05, 10, 15 or 20
Vertical Unit: 07, 12, 17, 22, 32 or 42
4. Heat Exchanger:
V = Vertical Plate (Vertical units)
T = Thermal Wheel (Vertical units)
H = Plate HX (Horizontal units)
5. Heater:
L = LPHW, E = Electric,
N = No Electric or LPHW
6. Cooling:
R = Reverse Cycle**
X = DX*
C = Chilled Water
N = No Cooling
7. Control type:
AT = Ecosmart Adapt (Trend), AS = Adapt Siemens
CO = Ecosmart Connect
ES = Ecosmart Classic
BC = Basic control
8. Handing:
L = Left, R = Right

*Condenser Unit and control by others.

**Ecosmart Connect & Adapt models only.

BPS BOXER PACKAGED SOLUTIONS - CONTROL OPTIONS CONSULTANTS SPECIFICATION

ECOSMART CLASSIC OPTION - DEMAND CONTROLLED VENTILATION

Provides the facility for energy saving via an intelligent stand-alone AHU function with local diagnostic status indication, or allows convenient integration with the client BMS with a minimal co-ordination requirement.

The factory fitted Ecosmart Classic control includes:- integral infinitely variable speed / duty control for the supply and extract fans, with independent minimum, maximum and offset adjustment for accurate commissioning. The control assembly is mounted internally. The control features a run on timer and "background" ventilation function, and is provided with unit status indication, run and fail relays and interface connections for Ecosmart Classic sensors/enablers and system dampers.

The heat exchanger bypass is automatically operated according to temperature and a pre-defined strategy.

***The heating output (LPHW or electric) is automatically regulated to control the Air - Off condition.

The Ecosmart control module can additionally be connected to provide the following integrated BMS interfaces.

- 0 - 10 volt inputs. This will enable the following functions:- Switch the unit ON/OFF. Variable speed / duty control, Switch from low speed to high speed, Enable heating/cooling.
- 2 No. Volt free contacts give fan run and failure unit status indication.

Units fitted with Ecosmart Classic control have a 5 year warranty.

ECOSMART CONNECT OPTION – ENHANCED DEMAND CONTROLLED VENTILATION

A comprehensive unit control specification - The control assembly is mounted internally, factory fitted and tested to provide guaranteed operation from a single supplier – one who will take responsibility.

The unit integrated Ecosmart Connect system provides the facility for operational efficiency and energy saving by allowing a comprehensive range of unitary control functions and / or full BMS integration (by others) via standard BACnet (MS/TP). The system incorporates a web access enabled controller, and is augmented by application specific unit interface and diagnostic circuits.

Controller software is optimised and pre-configured, and each unit / control assembly is fully functionally tested at works (Refer to technical documentation for full controller functional specification).

Units fitted with Ecosmart Connect control have a 5 year warranty.

ECOSMART ADAPT WITH TREND OPTION – ENHANCED

DEMAND CONTROLLED VENTILATION

A comprehensive unit control specification - The control assembly is mounted internally, factory fitted and tested to provide guaranteed operation from a single supplier – one who will take responsibility. The unit integrated Ecosmart Adapt system provides the facility for operational efficiency and energy saving by allowing a comprehensive range of unitary control functions and / or full BMS integration (by others) via standard BACnet IP configuration.

The system incorporates a web access enabled Trend IQ4E with 8DO expansion module controller, and is augmented by application specific unit interface and diagnostic circuits. Controller software is optimised and pre-configured, and each unit / control assembly is fully functionally tested at works.

(Refer to technical documentation for full controller functional specification).

Units fitted with Ecosmart Adapt control have a 5 year warranty. (Refer to 'Description of control' for further details).

The unit shall be manufactured by Nuair.

Note: The Reverse Cycle DX coil/Condenser can only be used with Ecosmart Connect or Adapt Control options.

The Mitsubishi condenser has a 3 year warranty.

Constant Pressure Control is standard on both Ecosmart Connect & Adapt Control options.

For Basic control option contact Nuair.

BPS BOXER PACKAGED SOLUTIONS - ECOSMART CONTROL PLATFORM - IT'S SO SMART IT'S SIMPLE

DEMAND VENTILATION SOLUTIONS – DESIGNED FOR EFFICIENCY AND PERFORMANCE

Nuaire have a pedigree for designing and manufacturing energy efficient ventilation equipment and matched control systems. Our very first control was produced in the late 1980's.

Nuaire was the first ventilation manufacturer to introduce low voltage energy saving control systems. Its fans with 'Ecosmart' technology varied the ventilation rate to suit occupant levels. Ecosmart was launched in 2002 and was revolutionary within the industry by providing the first "plug and play" control system.

Nuaire continues to lead in the industry with the expansion of their Ecosmart Controls Platform.



Energy efficient demand based control fitted with Trend IQ4E with 8DO expansion module controller. Allows for unitary control and full BMS integration via BACnet IP (by others).
Controller software is basic and ready for 'project specific' program to be loaded.
Ecosmart Adapt with Trend has a 5 year warranty.
For other options of Ecosmart Adapt contact Nuaire.



NEW Energy efficient demand based control providing a network connectivity and advanced functionality. Full BMS integration via BACnet (MS/TP). (Upgrade to IP network available).
Ecosmart Connect has a 5 year warranty.



UK's leading Energy Efficient 'plug and play' solution for over 20 years.
Provided with BMS interface, trickle and boost as standard.
Ecosmart Classic has a 5 year warranty.

THE MOST SUCCESSFUL ENERGY CONTROL EVER - DEMAND VENTILATION AT YOUR FINGER TIPS

BASIC CONTROL

For details on Basic control contact Nuaire.

ECOSMART ADAPT

TREND IQ4E WITH 8DO EXPANSION MODULE INSIDE WITH FULL BMS INTEGRATION VIA BACNET.

"The management and control of modern buildings grow ever more sophisticated. A Building Energy Management system (BEMS) must be tailored to suit each customer's specific control requirements. It must provide efficient HVAC control, coupled with the flexibility to accommodate changes in occupancy status and staff relocation at short notice; whilst simultaneously delivering improved comfort conditions. A BEMS must also provide real time management information and control, enabling customers to achieve significant energy savings". (TREND)

Ecosmart Adapt with Trend provides control of the ventilation including the heating, or cooling allowing unitary control and full BMS integration via BACnet IP. The Ecosmart Adapt with Trend control system includes an IQ4E controller which is pre-configured and the unit and control assembly is functionally tested at Nuaire before customer delivery.

REDUCED INSTALLATION & ON-SITE COMMISSIONING TIME ON NEW & RETROFIT PROJECTS -

Advanced tools within the control automate many tasks, simple to use displays minimise data input, whilst reducing commissioning time and potential human error.

- **Ease of use** - Using Ecosmart Adapt with Trend will deliver substantial savings on utility costs.
- **Peace of mind** - Ecosmart Adapt with Trend has a 5 year warranty.

ECOSMART CONNECT

Ecosmart Connect provides control of the ventilation including the heating, or cooling allowing unitary control and full BMS integration via BACnet (MS/TP). (Upgrade to IP network available).

The Ecosmart Connect controller is pre-configured and the unit and control assembly is functionally tested at Nuaire before customer delivery.

REDUCED INSTALLATION & ON-SITE COMMISSIONING TIME ON NEW & RETROFIT PROJECTS -

Advanced tools within the control automate many tasks, simple to use displays minimise data input, whilst reducing commissioning time and potential human error.

- **Ease of use** - Using Ecosmart Connect will deliver substantial savings on utility costs.
- **Peace of mind** - Ecosmart Connect has a 5 year warranty.

ECOSMART CLASSIC

Varying the ventilation rate in a building to suit changing occupant levels used to be an expensive option – Ecosmart brings this within everyone's pocket. Minimising energy losses through re-heating the air replaced through ventilation is at the top of the agenda; building regulations make this a necessity.

Ecosmart not only saves energy and carbon emissions it prolongs the life of the heat recovery unit.



Choosing Ecosmart is your reliable option, used by design engineers for many years and is now an integral feature of most Nuaire fans and AHUs.

- **Saves time on site** - Ecosmart controls are all pre-assembled, configured and installed directly into the units.
- **Simpler system** - No need for VCD (directly on the fan) no wasted energy or noise generation because air volume can be precisely set via integrated speed control.
- **Simple & precise commissioning** - As recommended in Part L, Ecosmart enables the system to be accurately commissioned via integrated speed control.

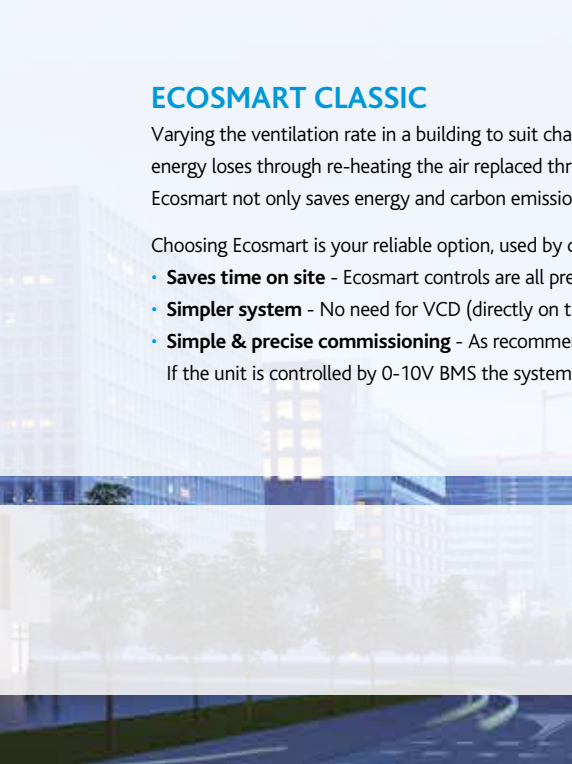
If the unit is controlled by 0-10V BMS the system responds to a 0-10V dc BMS signal – refer to Manufacturers I&M for detail.



BPS BOXER PACKAGED SOLUTIONS - ECOSMART CONTROL PLATFORM - IT'S SO SMART IT'S SIMPLE

	 BASIC CONTROL (BC)	 ecosmart classic (ES)	 ecosmart connect (CO) BACnet (MS/TP)	 ecosmart adapt (AT) Based on TREND IQ4E BACnet (IP)
CONTROLLER SOFTWARE				
Controller Software		N/A	Advanced Software	Basic Software (Can be re-written by others)
Heat Exchange Bypass Control Strategy		Basic	Optimised	Basic
Supply Temperature Control Strategy		Yes	Yes	Yes
Room Temperature Control Strategy		No	Yes	No
Switched Live Enable Input		Yes	Yes	Yes
Switched Live Fan Boost		No	No	Yes
Switched Live Configurable Input (Heat or Fan Boost)		No	Yes	No
Volt Free Enable Input		No	Yes	Yes
Volt Free Fan Boost		No	No	Yes
Volt Free Configurable Input (Heat or Fan Boost)		No	Yes	No
Trickle Mode		Yes	Yes	Yes
Fan Run-On		Yes	Yes	Yes
Fan Run-On (Intelligent)		No	Yes	No
Run/Fault/Heat/Cool Volt Free Outputs		Yes	Yes	Yes
I/O Damper control		Yes	Yes (via run relay)	Yes (via run relay)
Heat Dissipation Run-on		Yes	Yes	Yes
Frost Protection Routine		Yes	Yes	Yes
Low Supply Temp Fan Cut-out		No	Yes	Yes
Scheduling		Yes via ES-LCD	Yes	Yes
CO2 Based Fan PID Loop		ES CO2	Yes	Yes
Humidity Based Fan PID Loop		ES-HUMIDISTAT2	Yes	No
Constant Pressure Based Fan PID Loop		No	Yes	Yes
Night Cooling Mode		No	Yes	Yes
Purge Mode		No	Yes	Yes
Hibernate Mode (Open all valves)		No	Yes	No
Fan Speed Adjustment		Yes	Yes	Yes
Fan Speed Control only	Yes	No	No	No
0 - 10V Fan speed Input		Yes	Yes	Yes
0 - 10V Temperature Sensor Input		No	Yes	No
0 - 10V Humidity Sensor Input		No	Yes	No
0 - 10V Pressure Sensor Input		No	Yes	No
0 - 10V CO2 Sensor Input		No	Yes	No
CONTROLLER HARDWARE				
Fail safe thermal trip		Yes	Yes	Yes
Condensate Pump Monitoring		Yes	Yes	Yes
Din Rail Mounted Control		No	Yes	Yes
Quick Connect Terminals		No	Yes	Yes
24VAC Auxiliary		No	Yes	Yes

	BASIC CONTROL (BC)	ecosmart classic (ES)	ecosmart CONNECT (CO) BACnet (MS/TP)	ecosmart adapt (AT) Based on TREND IQ4E BACnet (IP)
HMI				
Commissioning Display		Yes only Via commissioning PCB	Yes	By Others
BACnet LCD Touch Screen Display		No	Yes	By Others
ROOM MODULES				
Plug & Play Sensors		Yes	Yes	No
Max Number of Sensors		32 devices on any system	4 sensor modules*	By Others
Quick connect plugs		Yes	Yes	By Others
Twisted pair cable compatible		No	Yes	By Others
Commissioning Port		No	Yes	By Others
Temperature		Yes	Yes	By Others
CO2		Yes	Yes	By Others
Humidity		Yes	Yes	By Others
3-Speed Override		No	Yes	By Others
PIR		Yes	Yes	By Others
Setpoint Adjust		Yes (on sensor)	Yes	By Others
Multiple Setpoints Supported		No	Yes	By Others
Room Temperature Display		No	Yes	By Others
Room Humidity Display		No	Yes	By Others
Fan Speed Display		No	Yes	By Others
Occupancy Status Display		No	Yes	By Others
Network Error Display		Yes	Yes	By Others
NETWORKING				
BEMS compatible		No	Yes	Yes
BMS compatible		0-10V Input	BACnet via MS/TP (BACnet via IP optional)	(BACnet via IP)
MONITORING				
Web connectivity		NA	Yes	Yes
Energy Monitoring		NA	Yes	Participation via Trend network
Energy Metering		NA	Yes	Participation via Trend network
			*Each sensor module can have multiple sensors.	
BPS SPECIFIC FEATURES				
Plug and play ancillary connections	Yes	Yes	Yes	Yes
Fan lighting with switches	Yes	Yes	Yes	Yes
HX Bypass Damper Control (On/Off only)	Terminals provided	Yes	Yes	Yes
Thermal Wheel Control (On/Off only)	Terminals provided	Yes	Yes	Yes
Inlet Outlet damper control	Terminals provided	Yes	Yes	Yes
Blocked filter switches	Terminals provided	Terminals provided	Yes	Yes
Recirculation Damper Control	Terminals provided	No	Yes	Yes
Chilled Water Control	Terminals provided	No	Yes	Yes
DX Cooling (via 3rd party condenser)	Terminals provided	No	Yes	Yes
DX Reverse Cycle	No	No	Yes	Yes
Constant Pressure Control	No	No	Yes	Yes

BPS BOXER PACKAGED SOLUTIONS - ECOSMART CONTROL PLATFORM - IT'S SO SMART IT'S SIMPLE

ecosmart classic SENSORS & ENABLERS

All Ecosmart Classic Systems must include at least one enabler.
(N.B. when used, BMS control and time clocks take over all other enablers).



ES-PIR2 (Enabler)
Detects movement and activates system. Incorporates a system status LED, overrun timer and timer adjustment.



ES-TEMP2 TEMPERATURE (Sensor)
Modulate fan speed based on room temperature. Incorporates two system status LEDs. (Green = OK, Red = Failure) and temperature set point level adjustment.



ES-THERMOSTAT2 (Enabler)
Activates the system when the temperature is above set point. Incorporates two system status LEDs. (Green = OK, Red = Failure) and temperature set point level adjustment.



ES-RH2 RELATIVE HUMIDITY (Sensor)
Modulate fan speed based on RH level. Incorporates two system status LEDs. (Green = OK, Red = Failure) and RH set point level adjustment.



ES-AV12 (Enabler)
When fan failure occurs the AVI will flash a warning. Supplied with pre-plugged 10m length of communication cable.



ES-CI SEMI-AUTOMATIC USER CONTROL
Fan, heating & cooling selected by external volt free switch, speed selected by 0-10V signal.



ES-HUMIDISTAT2 (Enabler)
Activates the system when the RH level is above set point. Incorporates two system status LEDs. (Green = OK, Red = Failure) and RH set point level adjustment.



ES-JB JUNCTION BOX
Designed to be compatible with Ecosmart System this unit is supplied with a pre-plugged 10 metre length of communications cable and has 8 further ports.



ES-CO2RM (Sensor)
ES-CO2RMPP (Sensor)
Surface mounted room carbon dioxide (CO₂) sensors incorporate a temperature sensor. RM = SELV option, RMPP complete with SELV AC powers supply.



ES-CO2 (Sensor)
Duct mounted sensor to modulate fan speed based on CO₂ levels. Connect to fan directly. Pre-wired with 2m cable (not adjustable).



ES-HTCSIG (Enabler)
Signal conditioning circuit for humidity, temperature and CO₂ sensors.



SWITCHED LIVE (by others)
Any mains voltage signal connected to the switched live terminal (S/L) in the unit. This affects the connected fan only.

ecosmart ROOM MODULES CONNECT



ESCO-TPL
Ecosmart Connect Room Module - Temperature and PIR.



ESCO-THS
Ecosmart Connect Room Module - Temperature and Humidity.



ESCO-TDPL
Ecosmart Connect Room Module - Temperature, Display and PIR.



ESCO-TDHL
Ecosmart Connect Room Module - Temperature, Display and Humidity. (Displays either temperature or humidity).



ESCO-TDHS
Ecosmart Connect Room Module - Temperature, Display and Humidity. (Humidity is not displayed).

TOUCH SCREENS & MANUAL USER CONTROLS



ES-LCD (Enabler) Touch screen user control in white incorporating time clock facility. This can control the function of the fan by manual setting or using a set of timed programs.



ES-UCF Manual 'on' and 'off' system user/speed control. Incorporates two system status LEDs (Green = OK, Red = Failure).



ESCO-LCD Touch screen display. The ESC-LCD is a user friendly operator interface featuring BACnet® communication and a colourful, graphic display with touch-screen interface. It is powered by 12-24VAC / VDC.



ESCO-TDS
Ecosmart Connect Room Module - Temperature and Display.



ESCO-TS
Ecosmart Connect Room Module - Temperature.



ESCO-CL
Ecosmart Connect Room Module - CO2.



ESCO-TDFS
Ecosmart Connect Room Module - Temperature, Display and Fan Speed Override.



ESCO-THPL
Ecosmart Connect Room Module - Temperature, Humidity and PIR.



ESCO-IPN
The BACnet IP to MS/TP Router exchanges information between networks and allows the controller to communicate on an IP network. One router is required for each MS/TP network.

THERMISTOR TEMPERATURE SENSORS



Code: TB/T1/S – For duct or immersion use. Short 150mm.
TB/T1/L – For duct use only. Long 400mm

Low cost thermistor sensors comprising insertion, clamp-on, and outside air versions. The insertion sensor may be used for duct or immersion purposes. It has a 6 mm diameter brass probe which is suitable for retrofit immersion applications and will fit most existing pockets (universal fitting kit option).

FEATURES

- Low cost
- High quality thermistors
- Brass probes
- M20 conduit entry with M16 cable gland
- IP67 housing
- Quarter turn quick release lid
- Easy to wire
- Universal kit option for retrofit of immersion sensors
- Adjustable insertion depth flange option for duct sensors

DUCT HUMIDITY & TEMPERATURE SENSORS



Code: HT/D – Duct and thermistor sensor (+/-3%).

Duct mounted relative humidity and temperature sensors for HVAC applications. The certified 2% high accuracy (/2%) and standard 3% versions offer excellent linearity and stability over a wide humidity range (10 to 90 %RH).

FEATURES

- Pre-calibrated for ease of commissioning
- IP65
- Operates over 10 to 100 %RH non-condensing
- ± 3% accuracy versions
- 2 part connectors for ease of installation
- Humidity sensor element protected by replaceable filter
- Capacitive humidity sensing element provides excellent long term stability
- Adjustable depth duct mounting flange option

CO2 SENSORS



Code: CO2/T/D – Duct sensor.
Code: CO2/T/S – Space carbon dioxide concentration and temperature sensor.

The CO2 duct and space sensors monitor the carbon dioxide concentration and temperature of the air. The space sensors have additional options of humidity monitoring and a 4 digit display. The display will show the measured values in succession. The duct sensor has a quick-release lid to facilitate installation.

FEATURES

- Low cost, high quality thermistor temperature sensor
- Humidity monitoring option for space sensor
- Optional digital display for space sensor
- IP67 housing (duct sensor)
- Quarter turn quick release lid (duct sensor)
- Two part terminals to facilitate wiring
- 24 Vac/dc supply
- Adjustable depth duct mounting flange option



IQVIEW4 Touch screen display. (6 x 4 inch).
FPK/Plate – Mounting plate.
IQVIEW4/SM BOX – Surface mount box for wall or panel.
Transformer for IQVIEW4 included.
ACC/24V - 230/24 VAC, 36 VA



IQVIEW8 Touch screen display. (10 x 6 inch).
IQVIEW8/SM BOX – Surface mount box for flat surfaces.
Transformer for IQVIEW8 included.
ACC/24V – 230/24 VAC, 36 VA



SDU Display.
RD/SDU-IQ2COMMSCABLE/3m – RJ11 plug to RJ11 plug cable (3m) for SDU.



FOR MORE INFORMATION

www.nuaire.co.uk

COMMERCIAL

www.nuaire.co.uk/commercial



NUAIRE

Western Industrial Estate | Caerphilly | CF83 1NA

t +44 (0)29 2085 8200 | f +44 (0)29 2085 8222 | e enquiries@nuaire.co.uk

www.nuaire.co.uk

As part of our policy of continuous product development Nuaire reserves the right to alter specifications without prior notice.
Telephone calls may be recorded for quality and training purposes.

Part Number 671738 May 2018/issue v8